



Arkay Windows

TECHNICAL DOCUMENTS

Heritage Doors

Heritage Door

58BD HI ENTRANCE DOOR

Available in a wide range of styles and formats, our stylish aluminium Entrance door system is suitable for both light and medium-duty use. Designed with security and flexibility front of mind, every door in the range is available in single and double configurations making them ideal for almost any application.

PRODUCT FEATURES

- Certified under the Secured By Design scheme
- Multi-point locking mechanism
- Part L compliant for new build and replacement
- Intergrated deep head for trickle vents
- PAS24 Certified

OPTIONS

- Glazing 24mm – 40mm
- 58mm or 70mm frame depth
- Low threshold option
- Single, dual and anodised finishes
- Available in single or double door configuration
- Standard, Thumbturn & 3* cyclinders options
- Electric lock available
- Door Restrictors available

■ Meeting Stile Detail

■ Cill Detail
Low Threshold

■ Cill Detail
Standard Threshold

SPECIFICATIONS

| PERFORMANCE & ACCREDITATION | SINGLE OPEN IN | SINGLE OPEN OUT | DOUBLE OPEN IN | DOUBLE OPEN OUT |
|-----------------------------|------------------------|------------------------|------------------------|------------------------|
| Air permeability | Class 4 (600 Pa) | Class 4 (600 Pa) | Class 3 (600 Pa) | Class 3 (600 Pa) |
| Water penetration | Class 3a (100 Pa) | Class 7a (300 Pa) | Class 7a (300 Pa) | Class 9a (600 Pa) |
| Wind resistance | Class A3 (1200 Pa) | Class AE2400 (2400 Pa) | Class A3 (1200 Pa) | Class A4 (1600pa) |
| Building regulations part L | ☐ | ☐ | ☐ | ☐ |
| Building regulations part M | ☐ | ☐ | ☐ | ☐ |
| *U-value (double glazing) | 1.3 W/m ² K | 1.3 W/m ² K | 1.3 W/m ² K | 1.3 W/m ² K |
| †U-value (triple glazing) | 1.1 W/m ² K | 1.1 W/m ² K | 1.1 W/m ² K | 1.1 W/m ² K |
| 3rd party certification | Q-mark | Q-mark | Q-mark | Q-mark |
| PAS24 Certified | ☐ | ☐ | ☐ | ☐ |
| Secured by design | Yes | Yes | Yes | Yes |
| Durability EN1191 category | 50,000 Cycles | 50,000 Cycles | 50,000 Cycles | 50,000 Cycles |

DESIGN FEATURES

| | | | |
|---------------------------|-----------------|--------------------------------|-------------|
| Minimum door leaf size | 600mm x 1560mm | Sightline (Head) | 120mm/130mm |
| Maximum door leaf size | 1200mm x 2400mm | Low Threshold Sightline (Cill) | 111 mm |
| Maximum door leaf weight | 90 kg | Sightline (Jamb) | 130mm |
| Maximum glazing thickness | 24mm - 40mm | Sightline (Meeting Stile) | 210 mm |

CILL OPTIONS

| | | | | |
|----------------|------------|------------|------------|------------|
| 90mm stub cill | 150mm cill | 180mm cill | 230mm cill | 300mm cill |
|----------------|------------|------------|------------|------------|

APPLICATIONS

| | | | | |
|---------------|---|---|---|---|
| New build | ☐ | ☐ | ☐ | ☐ |
| Refurbishment | ☐ | ☐ | ☐ | ☐ |

HANDLE OPTIONS

| LEVER HANDLE | POLE HANDLE | PAD HANDLE |
|--------------------|------------------------|------------------|
| White lever/lever | 1200 S/S Pole & Lever | White lever/pad |
| Black lever/lever | 1200 S/S Pole In & Out | Black lever/pad |
| Grey lever/lever | 1500 S/S Pole & Lever | Silver lever/pad |
| Silver lever/lever | 1500 S/S Pole In & Out | Chrome lever/pad |
| Chrome lever/lever | 1800 S/S Pole & Lever | Gold lever/pad |
| Gold lever/lever | 1800 S/S Pole In & Out | |
| Dual lever/lever | | |
| Lever/Blank Plate | | |

COLOURS

| | | | |
|---|-------------------|---------------------|----------------------|
| Standard Colours | RAL7016 Matt Grey | RAL 9005 Matt Black | RAL 9910 Gloss White |
| We are able to manufacture in over 200 single, dual and anodised finishes to match your project | | | |

* U-Value (Double Glazing) - Single Doors are calculated using EN ISO 10077 - Part 2, 1000mm x 2180mm Single Door with Ug: 1.0 W/m²K using AW604 outerframe and AD200/AD201 vent. Double Doors are calculated using EN ISO 10077 - Part 2, 2000mm x 2 using AW604 outerframe and AD200/AD201 vent.

† U-Value (Triple Glazing) - Single Doors are calculated using EN ISO 10077 - Part 2, 1000mm x 2180mm Single Door with Ug: 0.7 W/m²K using AW604 outerframe and AD200/AD201 vent. Double Doors are calculated using EN ISO 10077 - Part 2, 2000mm x 2 using AW604 outerframe and AD200/AD201 vent.

Heritage - Contents

- 1.0 Typical Elevations
- 2.0 Standard Profiles
- 3.0 Typical Sections
 - 3.1 Threshold - Rebated Frame Open Out
 - 3.2 Threshold - Rebated Frame Open In
 - 3.3 Head - Open Out
 - 3.4 Head - Open In
 - 3.5 Head - Extended Frame with Trickle Vent
 - 3.6 Hinged Jamb - Open Out
 - 3.7 Locking Jamb - Open Out
 - 3.8 Hinged Jamb - Open In
 - 3.9 Locking Jamb - Open In
 - 3.10 French Door - Meeting Open Out
 - 3.11 French Door - Meeting Open In
 - 3.12 U43240 - 46mm Sash Transom
 - 3.13 Threshold - Rebated Frame Sill Options
 - 3.14 Fixed Frame Capped Transom
 - 3.15 Frame - Reinforced Coupler
 - 3.16 Frame Transom Above Sashes Open Out
 - 3.17 Frame Transom Above Sashes Open In

Heritage - Elevations

SINGLE HERITAGE DOORS

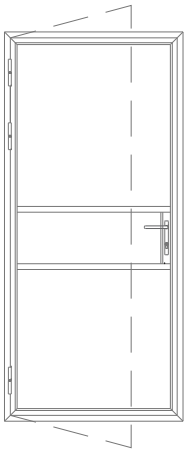

Left Hinged
Open Out

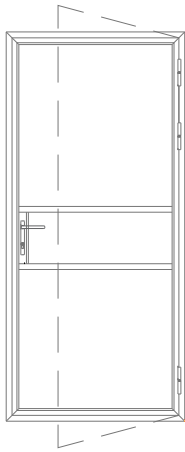

Right Hinged
Open Out

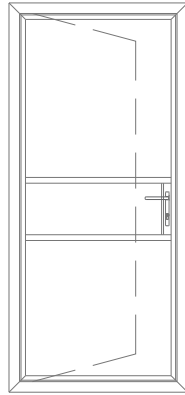

Left Hinged
Open In

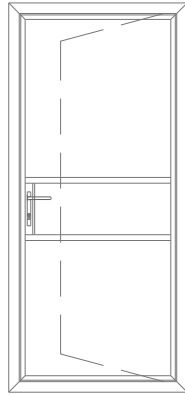

Right Hinged
Open In

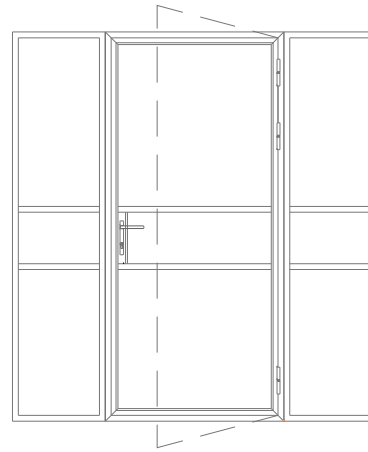

Right Hinged
Side Light

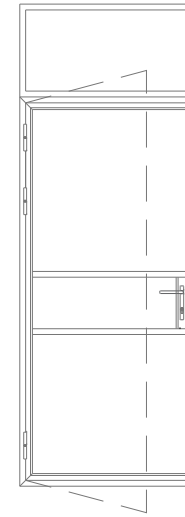

Left Hinged
Top Light

FRENCH HERITAGE DOORS

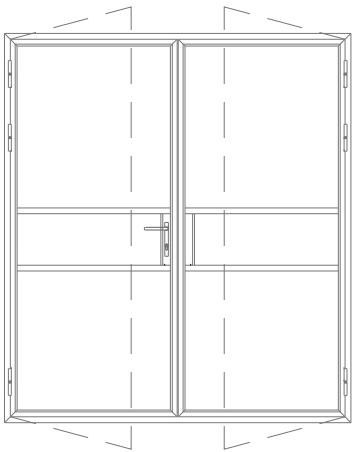

Left Master
Open Out

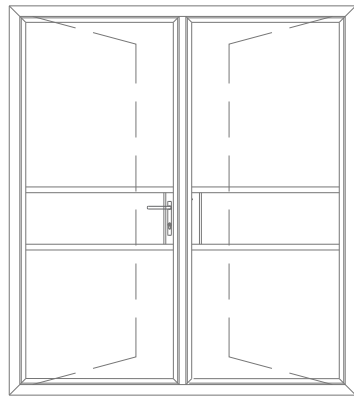

Left Master
Open In

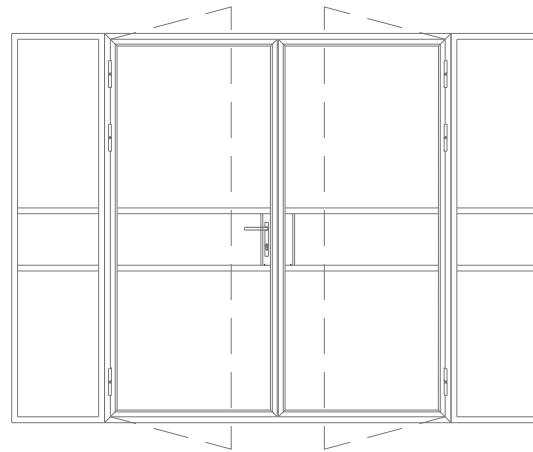

Left Master
Side Light

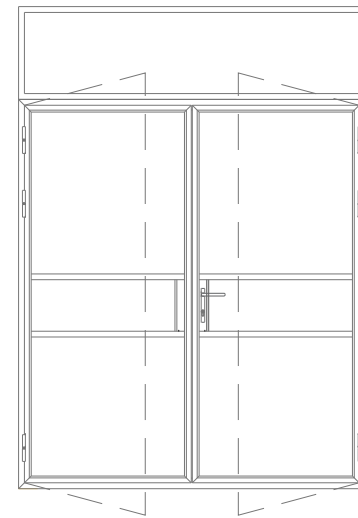

Right Master
Top Light

Heritage - Profiles

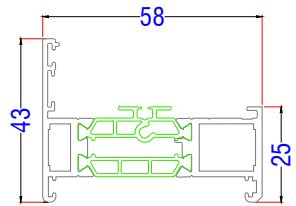

U44008 - Outer Frame

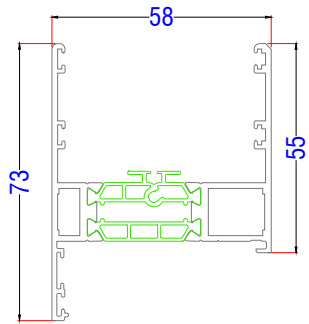

U44012 - Deep Outer Frame

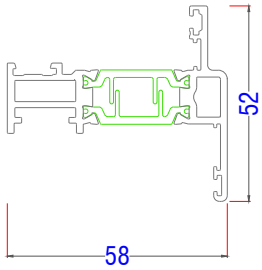

U43300 - Feature Door Leaf Open Out

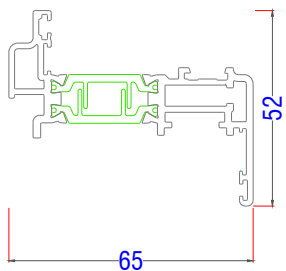

U43301 - Feature Door Leaf Open In

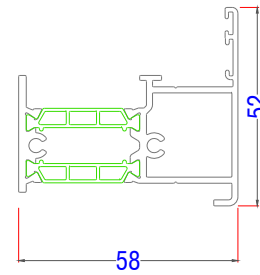

U43621 - Rebated Floating Mullion Open Out

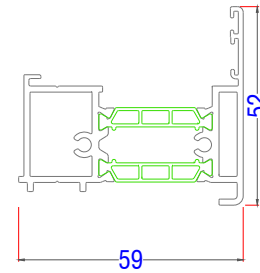

U43622 - Rebated Floating Mullion Open In

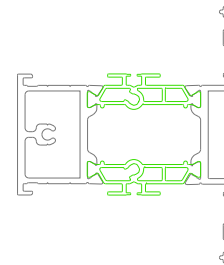

U43621 - Rebated Floating Mullion Open Out

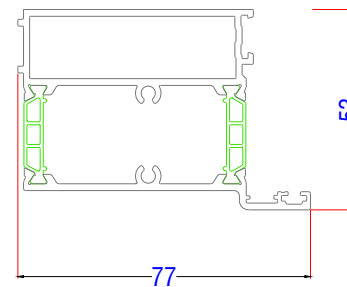

U43241 - Door Lock Box

Heritage - Profiles

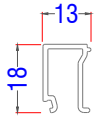

N43802 - Door Sash Bead 28mm IGU

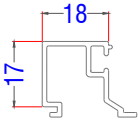

AW660 - Square Bead 28mm IGU

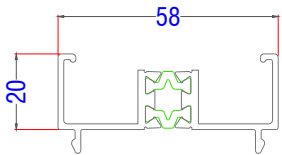

AW725 - 20mm Frame Extender (58mm)

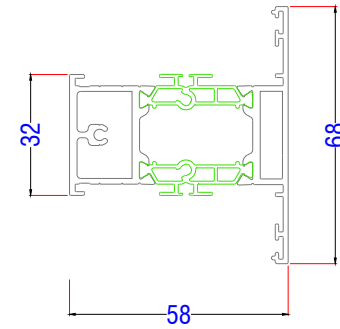

U44047 - Medium Flat Transom

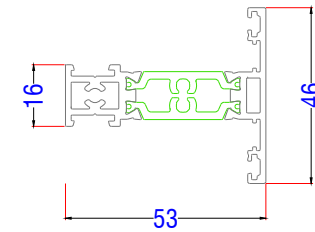

U43240 - Slim Door Leaf Transom/Mullion

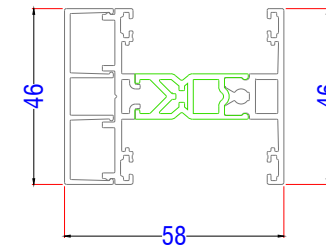

(N43625, N43624, N43623, V31943)
Slim Frame Transom (Capped)



N43625 - Int. Transom Cover Cap (Frame)



N43624 - Int. Transom Pressure Plate (Frame)

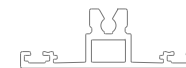

N43623 - Ext. Transom (Frame)



V31943 - 30mm Transom Isolator (Frame)

Heritage - Profiles

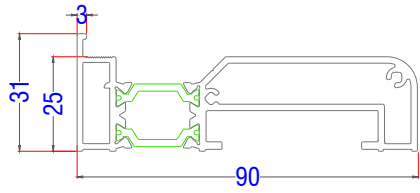

Cor-3836 - 90mm Stub Nose Cill

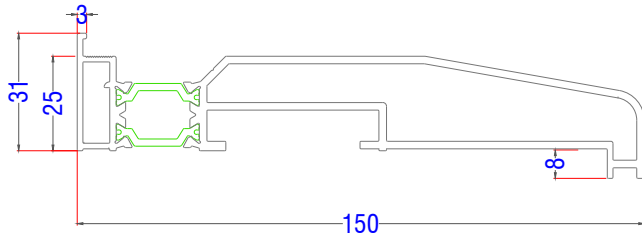

Cor-3735 - 150mm Drop Nose Cill

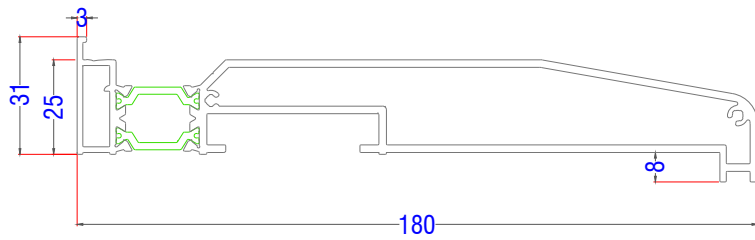

Cor-3837 - 180mm Drop Nose Cill

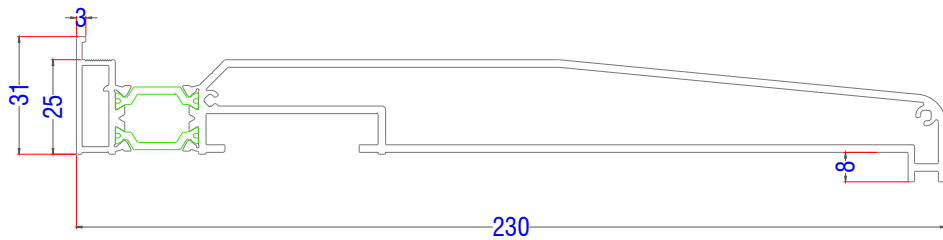

Cor-3838 - 230mm Drop Nose Cill

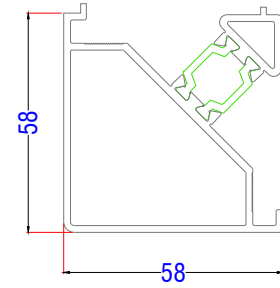

AW721 - 90deg Corner Post (58mm)

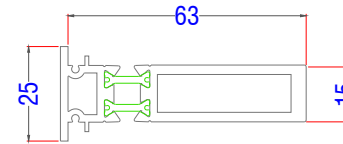

AW703 - 15mm Coupler Bar

Heritage - Typical Sections

Threshold - Rebated Frame Open Out

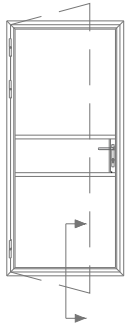

INSIDE

OUTSIDE

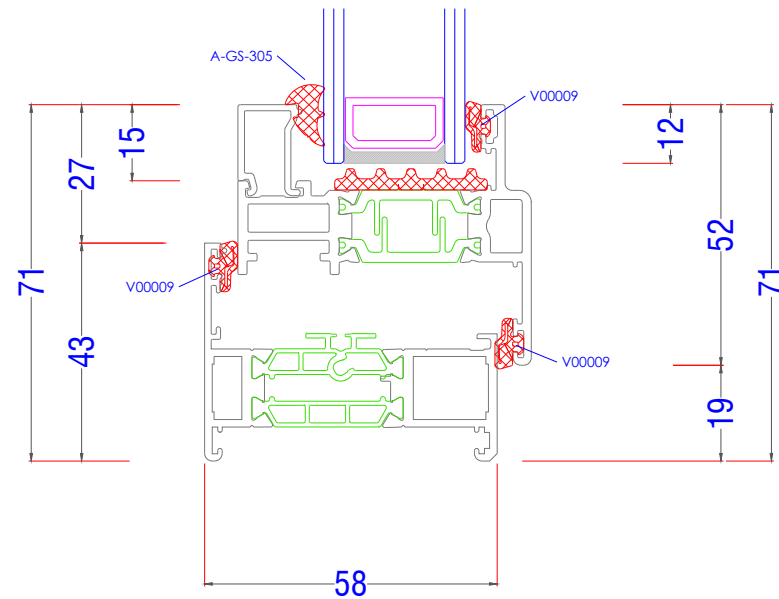

Heritage - Typical Sections

Threshold - Rebated Frame Open In

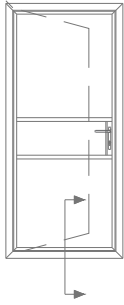

INSIDE

OUTSIDE

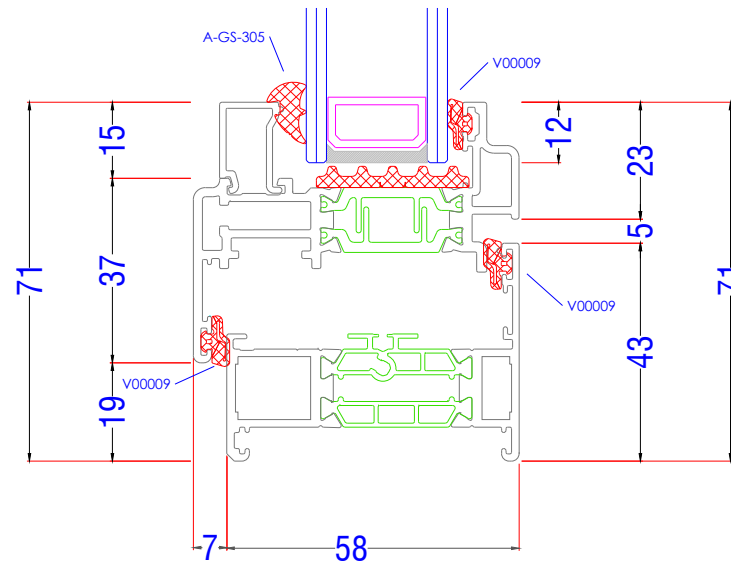

Heritage - Typical Sections

Head - Open Out

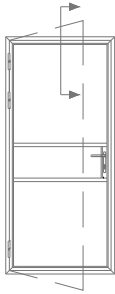

INSIDE

OUTSIDE

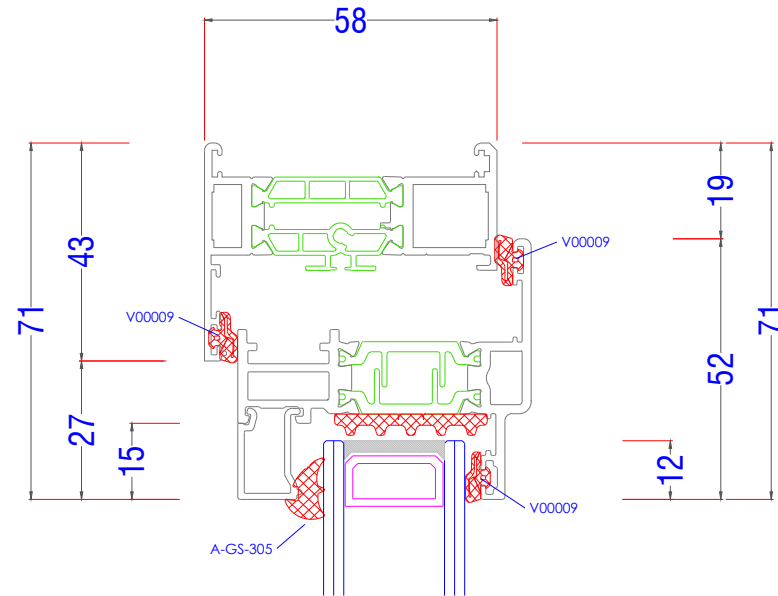

Heritage- Typical Sections

Head - Open In

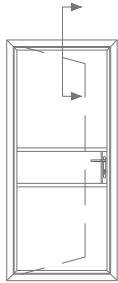

INSIDE

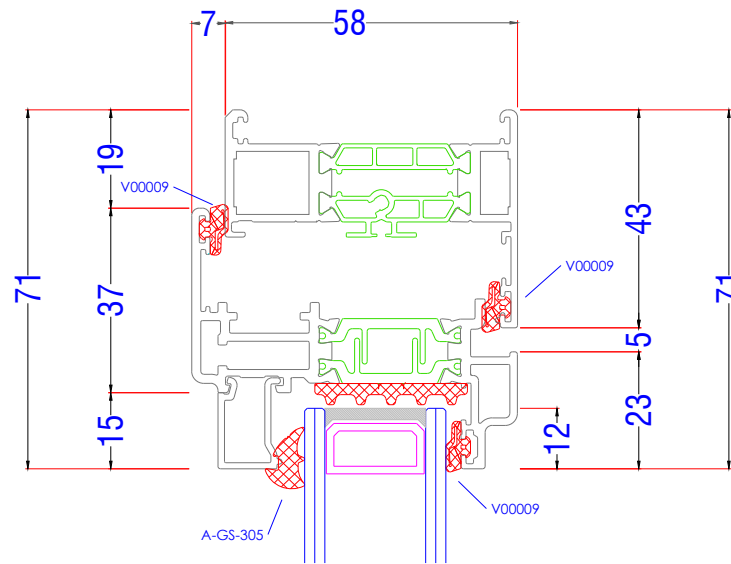

OUTSIDE

Heritage - Typical Sections

Head - Extended Frame with Trickle Vent

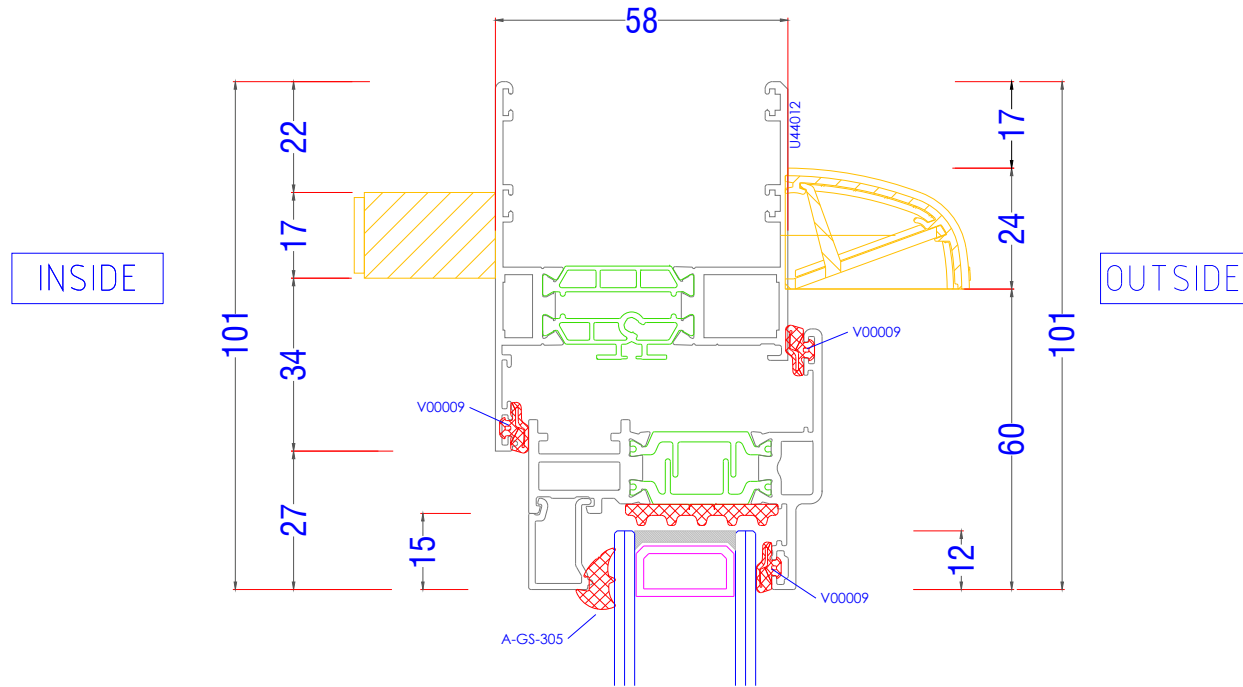
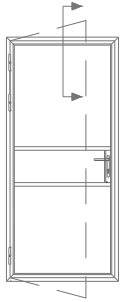

Heritage- Typical Sections

Hinged Jamb - Open Out

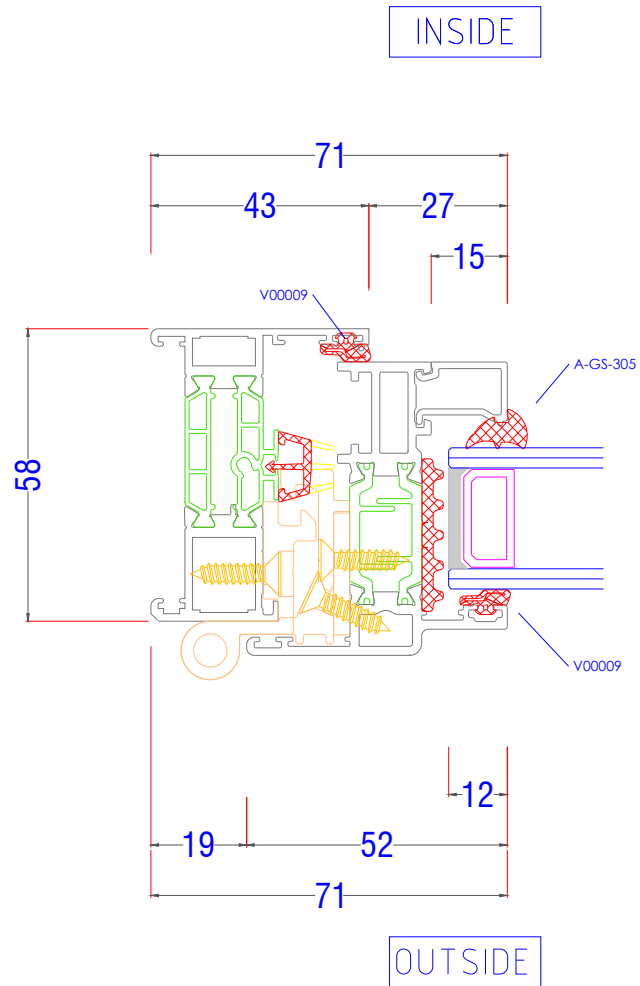
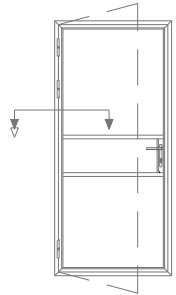

Heritage - Typical Sections

Locking Jamb - Open Out

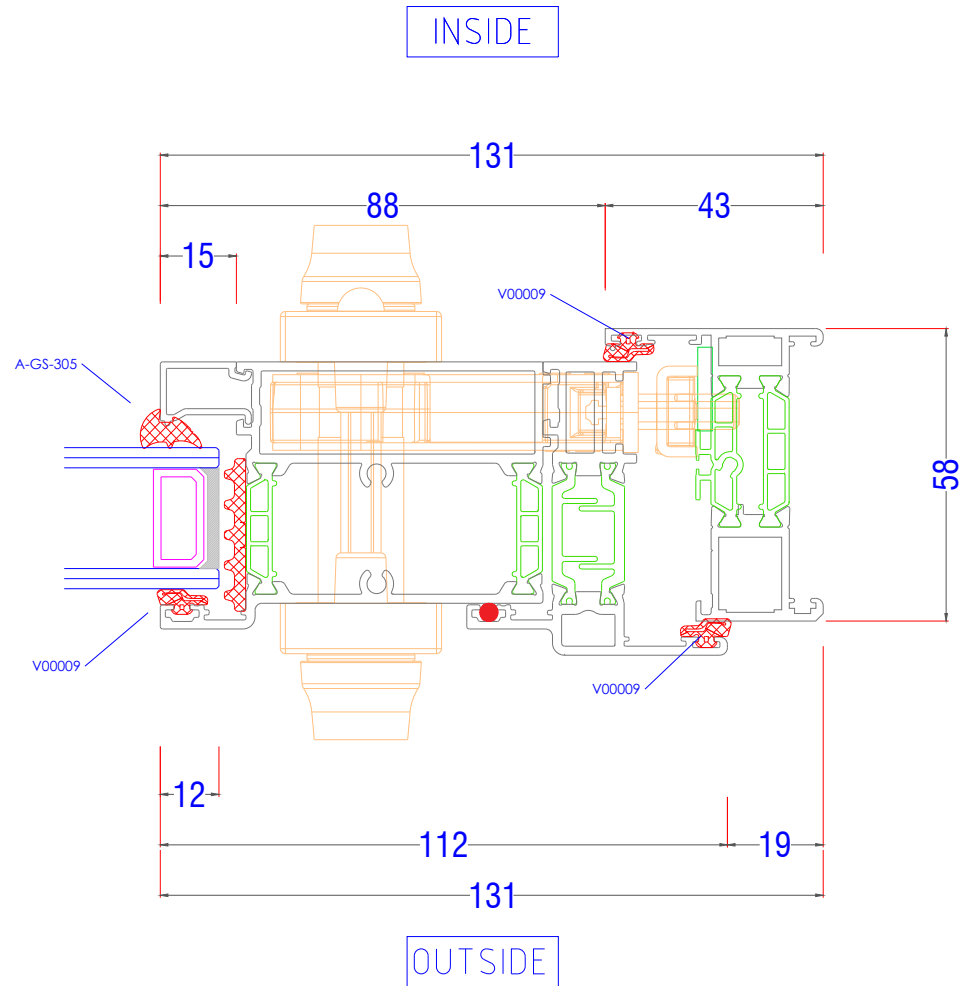
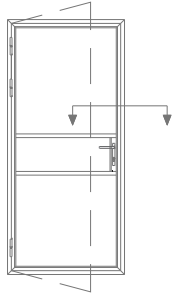

Heritage - Typical Sections

Hinged Jamb - Open In

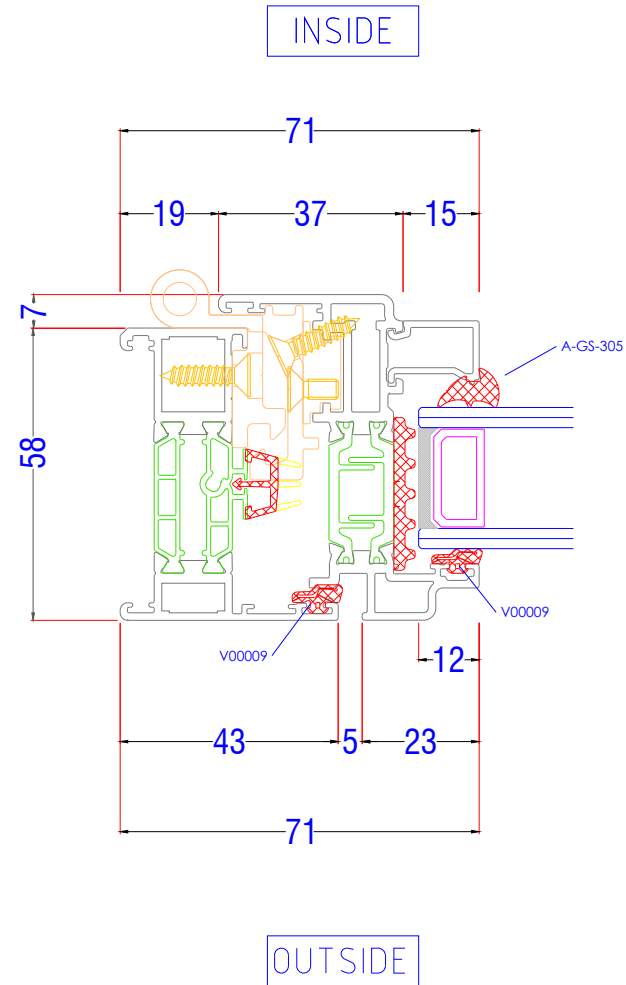
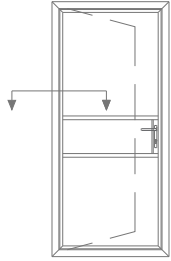

Heritage - Typical Sections

Locking Jamb - Open In

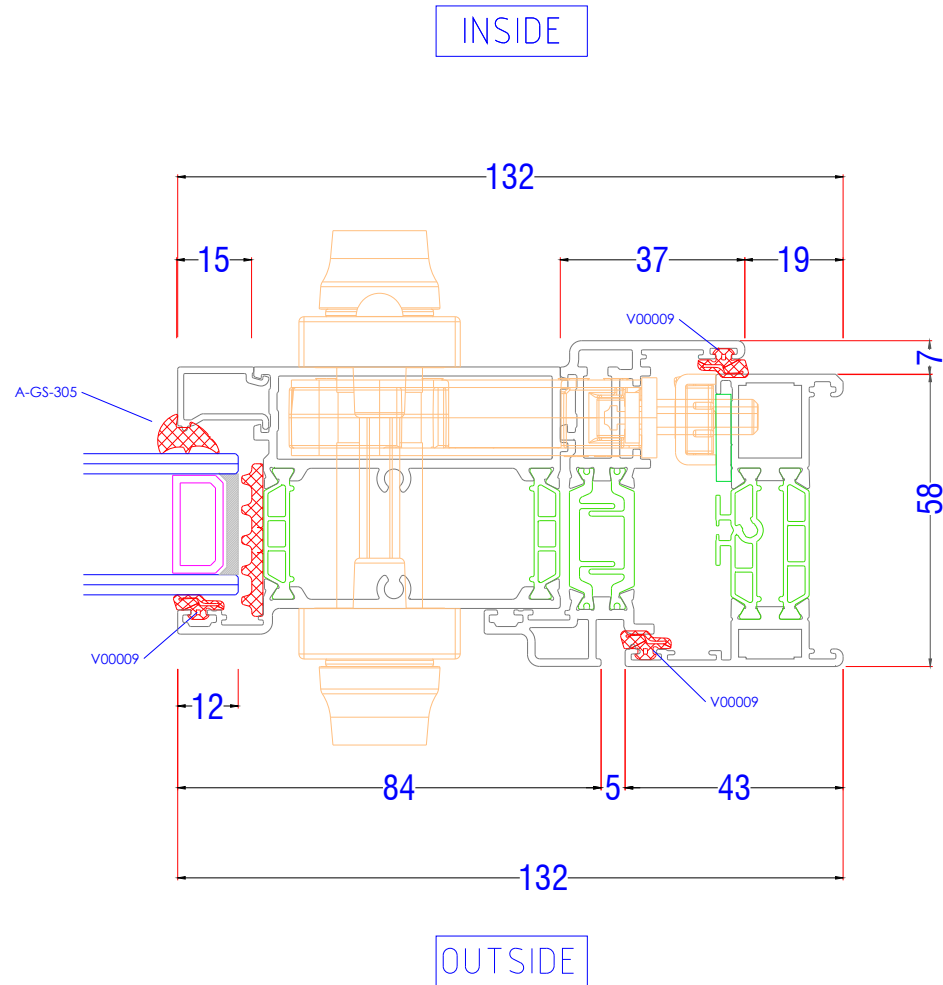
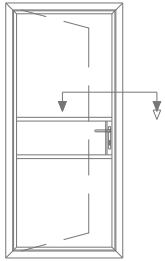

Heritage - Typical Sections

French Door - Meeting Open Out

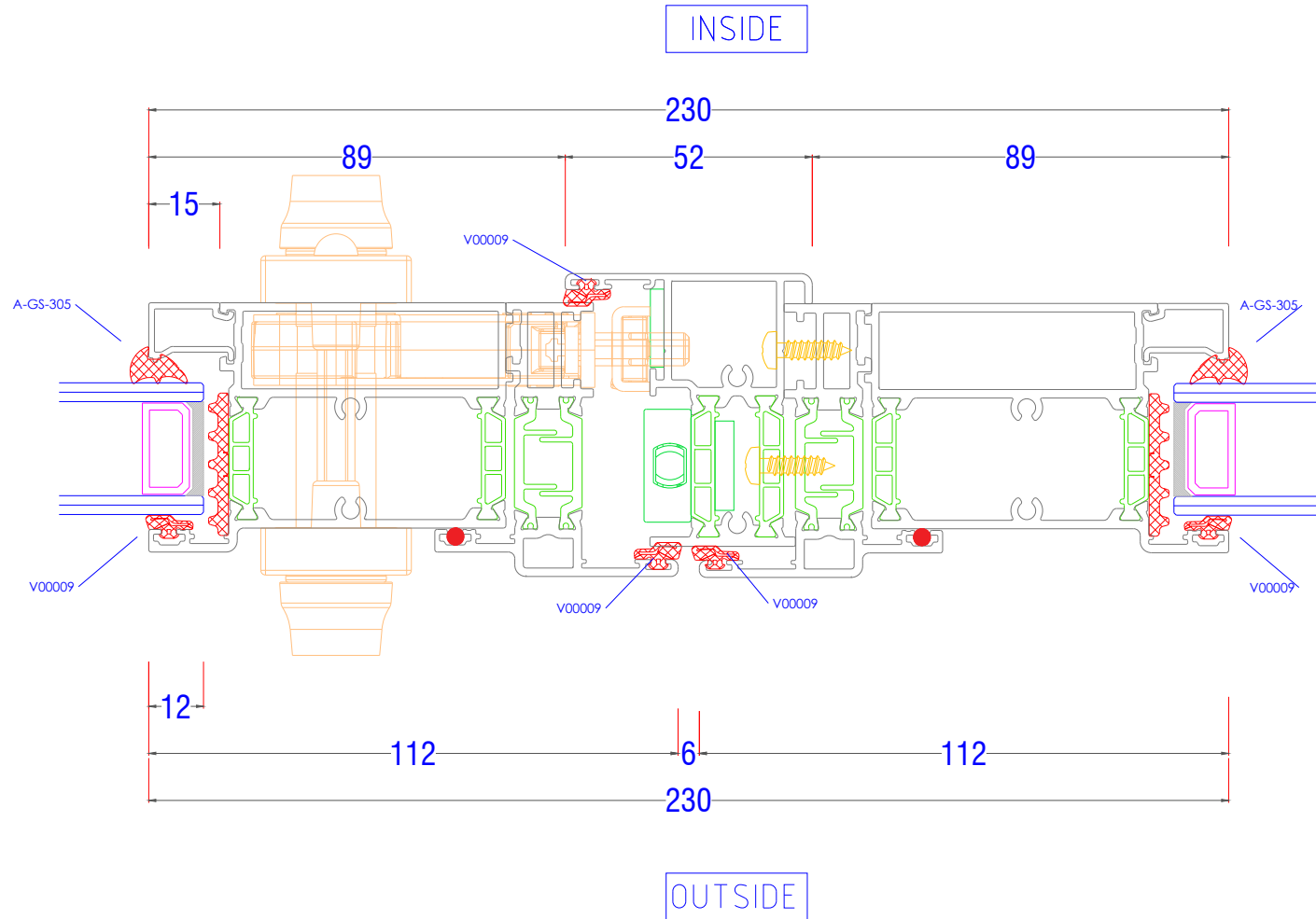
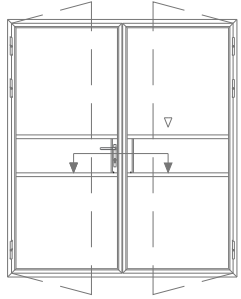

Heritage - Typical Sections

French Door - Meeting Open In

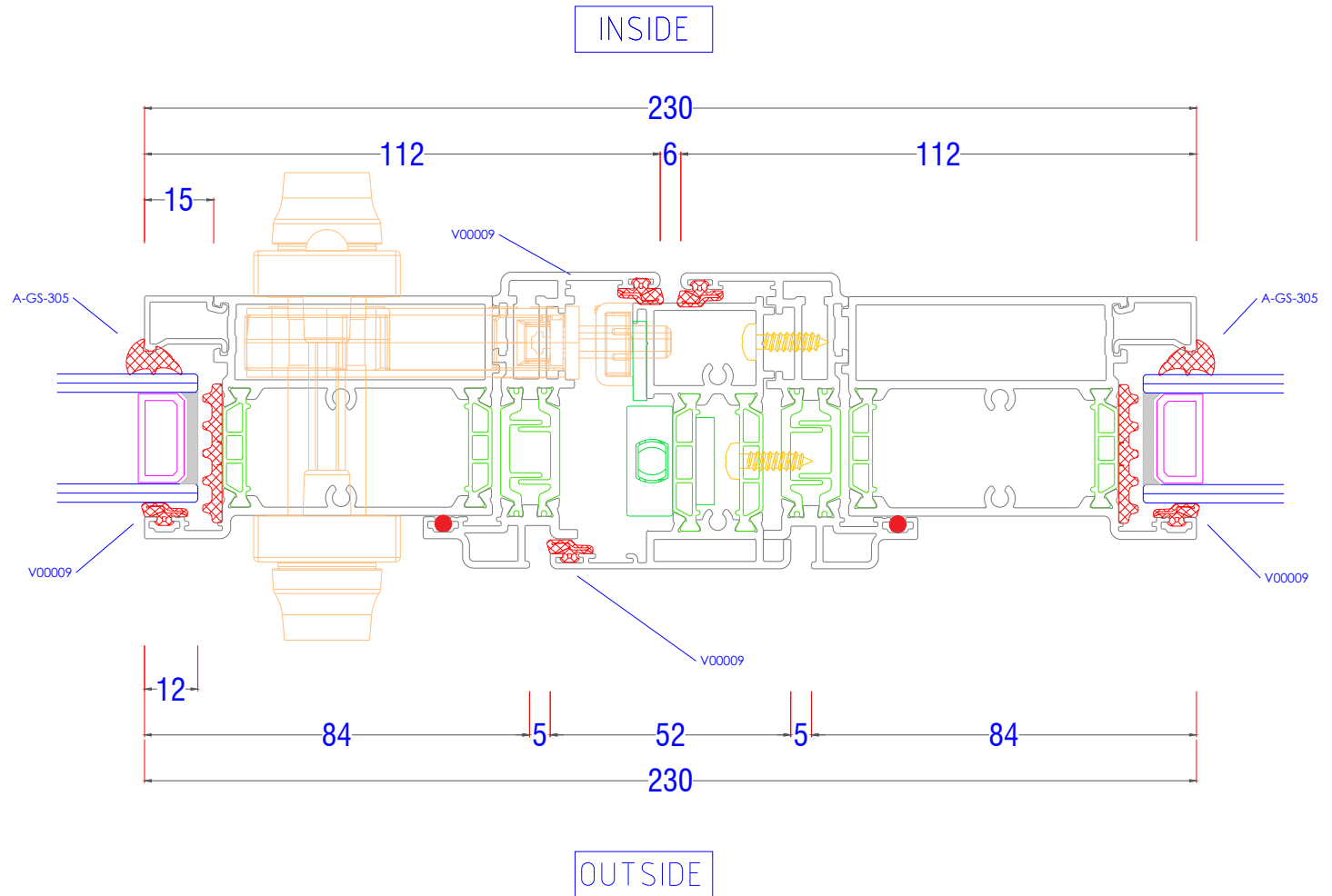
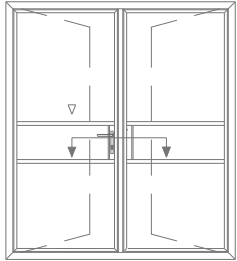

Heritage - Typical Sections

U43240 - 46mm Sash Transom

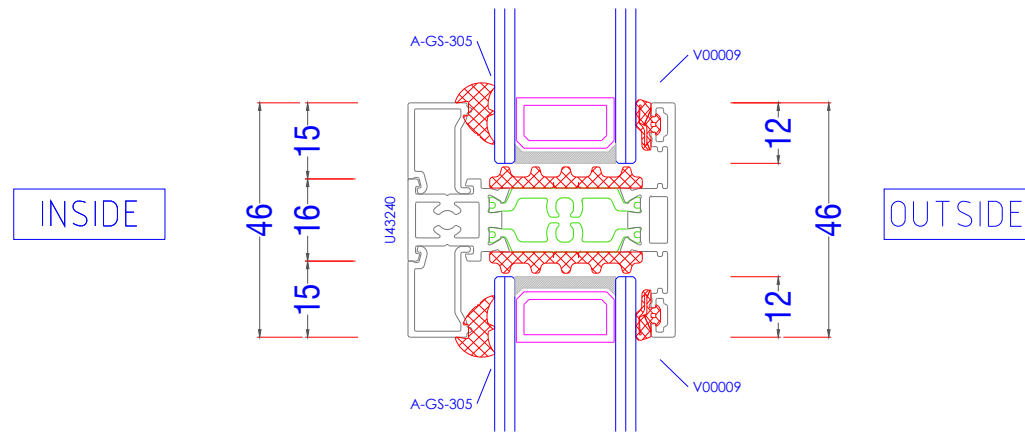
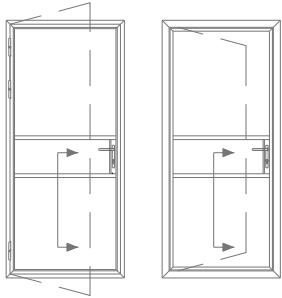

Heritage - Typical Sections

Threshold - Rebated Frame Sill Options

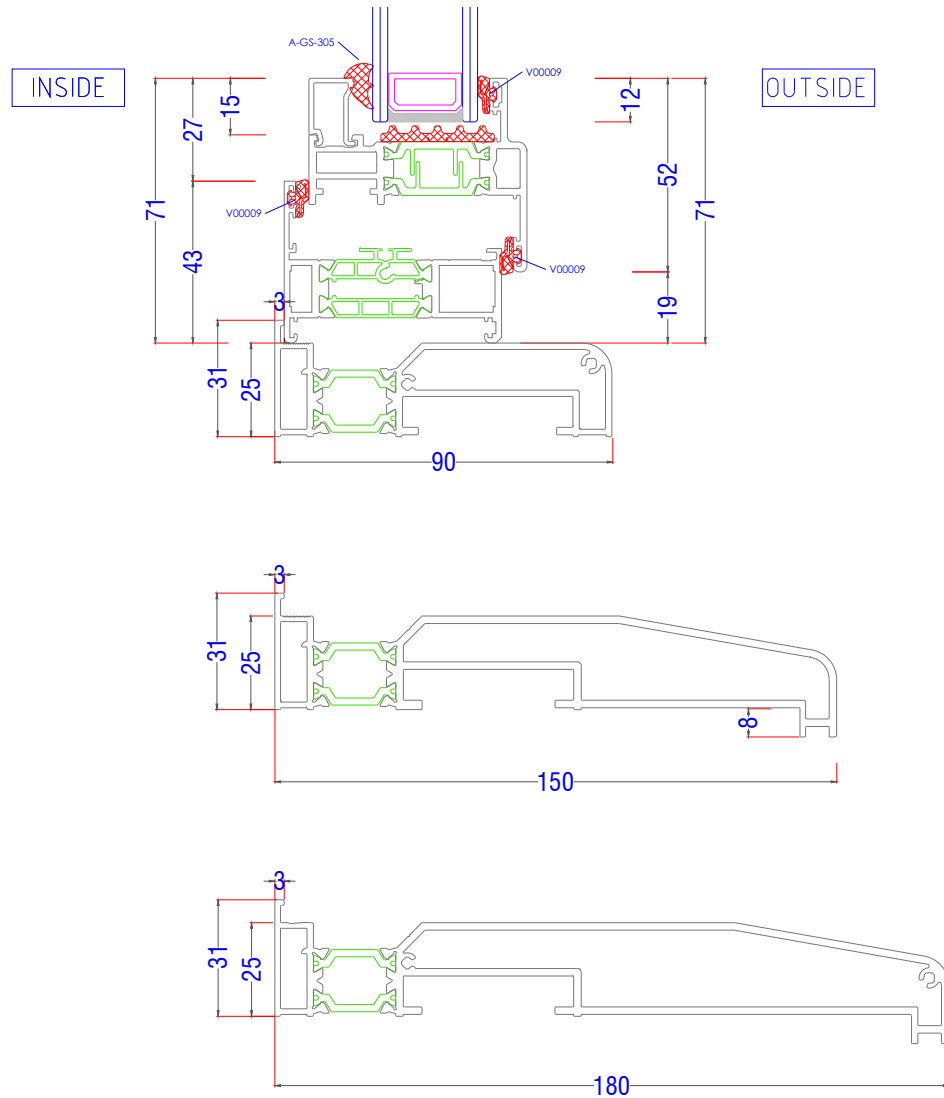
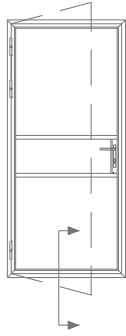

Heritage - Typical Sections

Fixed Frame Capped Transom

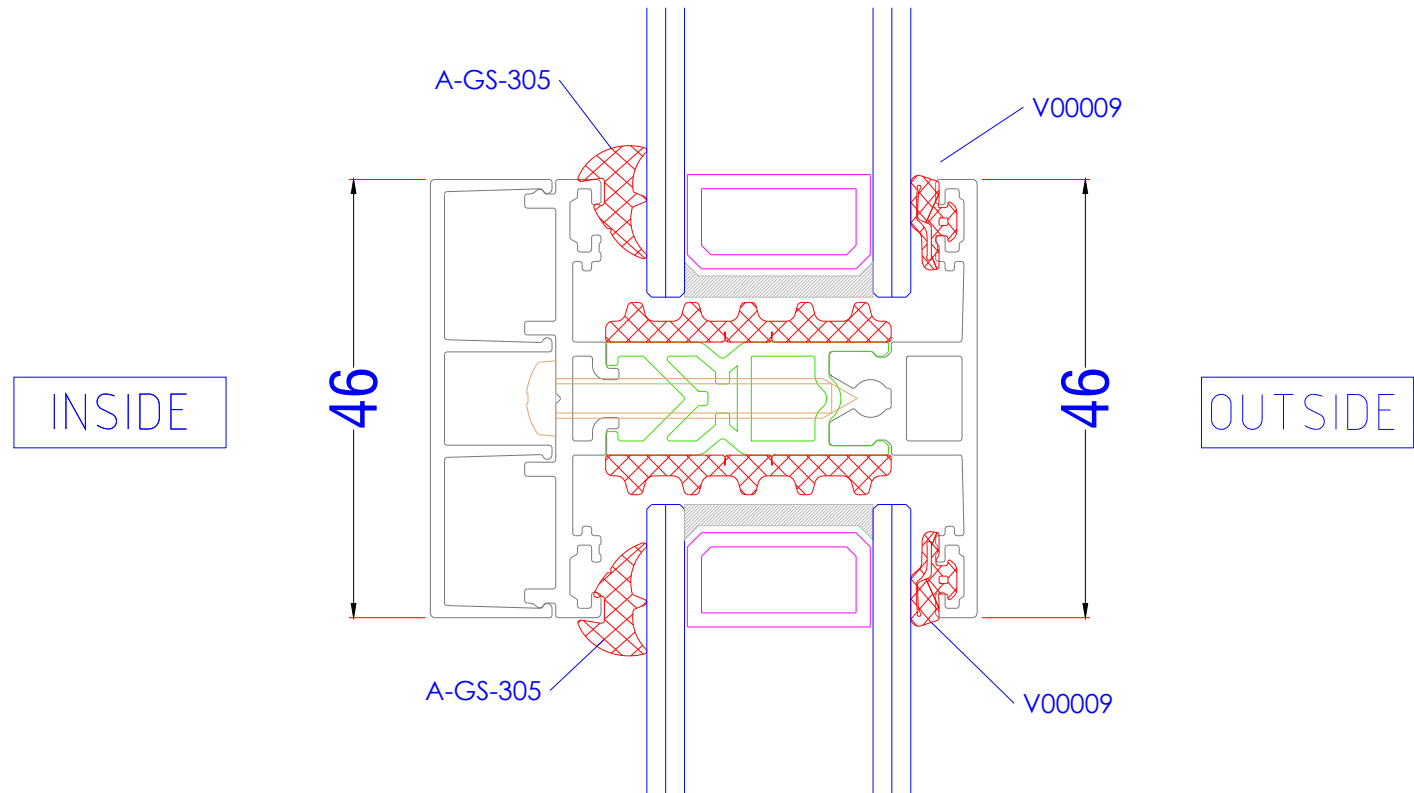
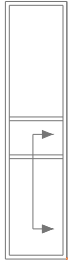

Heritage - Typical Sections

Frame - Reinforced Coupler

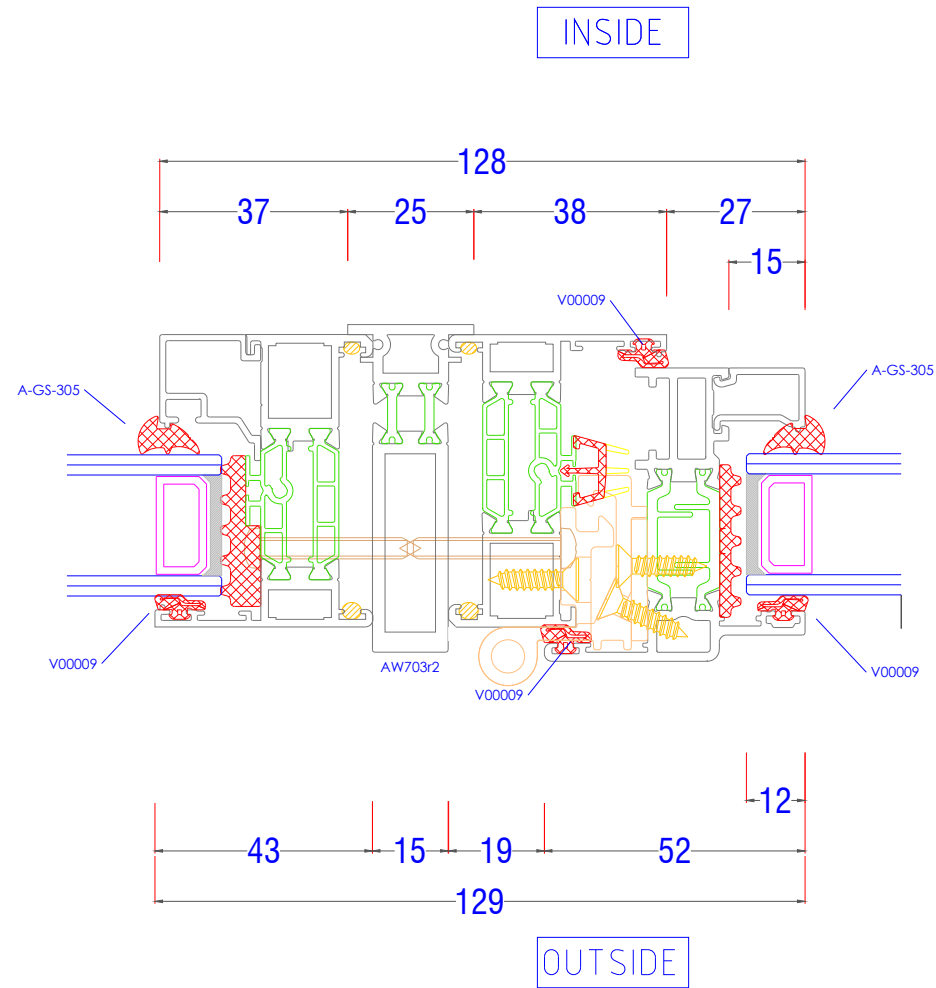
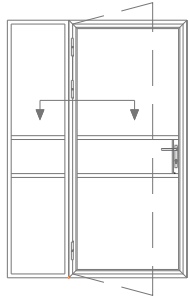

Heritage - Typical Sections

Frame Transom Above Sashes Open Out

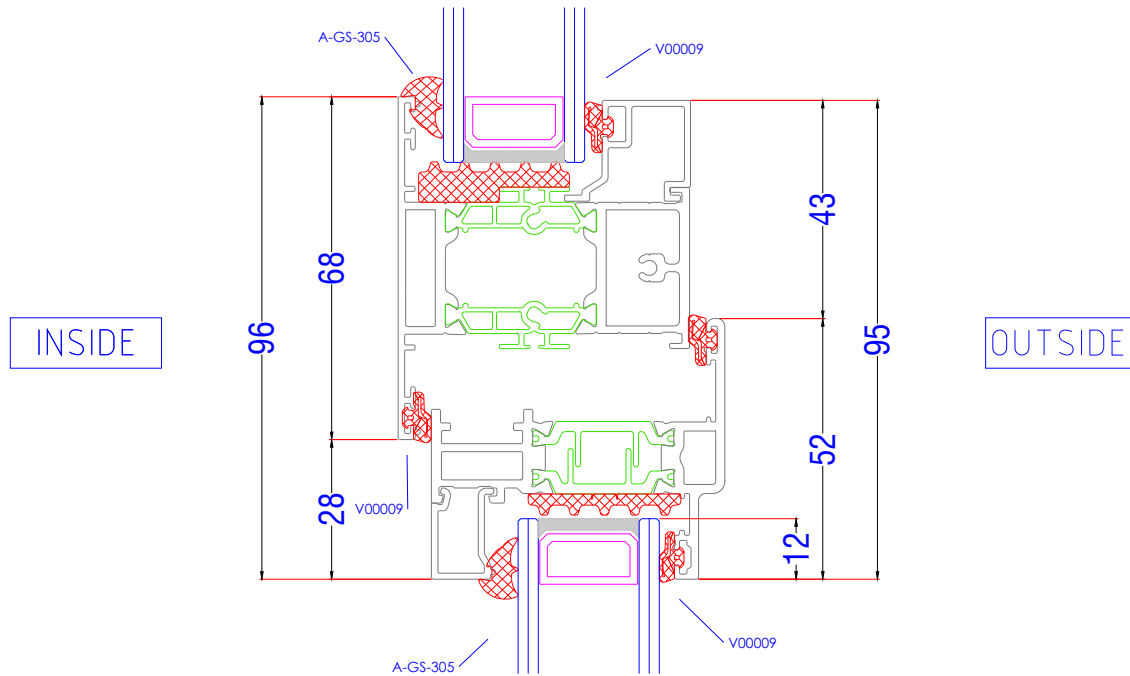
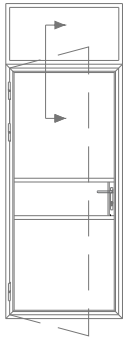

Heritage - Typical Sections

Frame Transom Above Sashes Open In

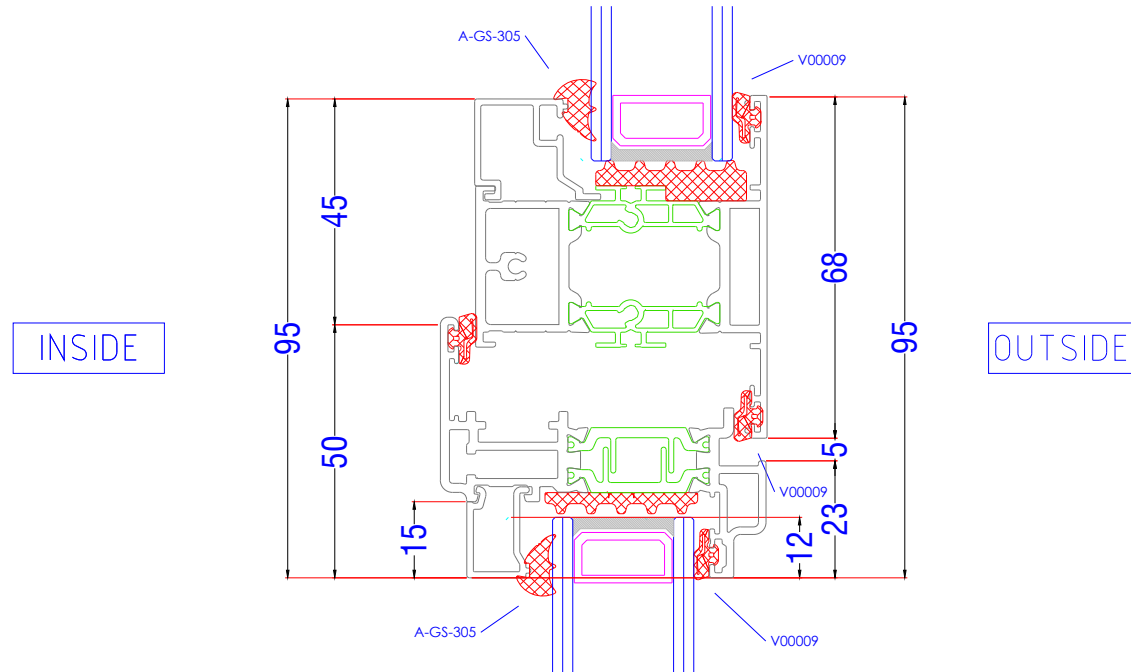
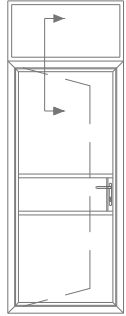



Class & Glazing Federation Member

Official Police Security Initiative

Arkay Windows is a specialist large-scale fabricator with over 30 years experience based in Watford, North West London.

Through growth built on putting our customers first, we have risen to supply some of the country's biggest retail companies, contractors and commercial installers.

 **Arkay Windows**

Watford: 01923 803923
London: 020 8889 6821

sales@arkaywindows.com
www.arkaywindows.com

