



**Arkay Windows**

**TECHNICAL DOCUMENTS**

**Glide 21**

# Glide 21 - Contents

- 1.0 Typical Elevations
- 2.0 Standard Profiles
- 3.0 Typical Sections
  - 3.1 Duo Frame - Fixed Jamb
  - 3.2 Duo Frame - Locking Jamb
  - 3.3 Tri Frame - Fixed Jamb
  - 3.4 Tri Frame - Locking Jamb
  - 3.5 Duo Frame - Fixed Panel Threshold
  - 3.6 Duo Frame - Sliding Panel Threshold
  - 3.7 Tri Frame - Fixed Panel Threshold
  - 3.8 Tri Frame - Sliding Panel Threshold
  - 3.9 Duo Frame - Fixed Panel Head
  - 3.10 Duo Frame - Sliding Panel Head
  - 3.11 Tri Frame - Fixed Panel Head
  - 3.12 Tri Frame - Sliding Panel Head
  - 3.XX Interlocks
    - 3.13a Standard
    - 3.13b Standard - Reinforced Outside Only
    - 3.13c Standard - Reinforced Inside & Outside
  - 3.14 Meeting Section

# Glide 21 - Typical Elevations

DUAL TRACK  
APPLICABLE FOR IN-LINE SLIDING

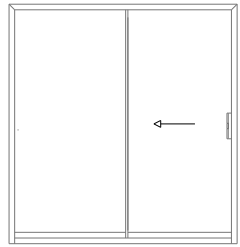

DUO RAIL  
0X

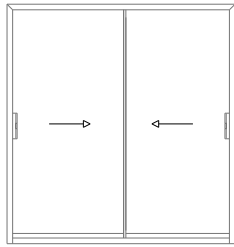

DUO RAIL  
XX

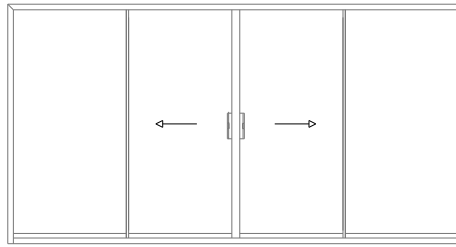

DUO RAIL  
0XX0

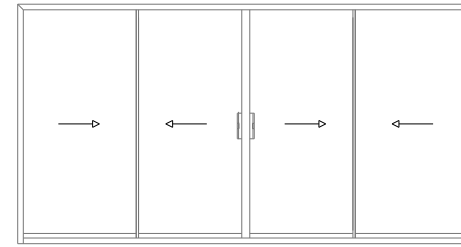

DUO RAIL  
XXXX

TRIPLE TRACK  
APPLICABLE FOR IN-LINE SLIDING

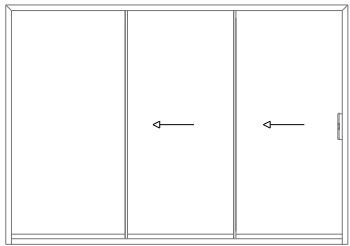

TRI RAIL  
0XX

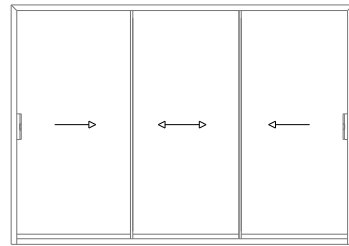

TRI RAIL  
XXX

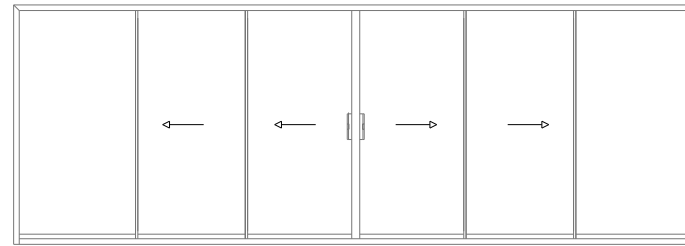

TRI RAIL  
0XXXX0

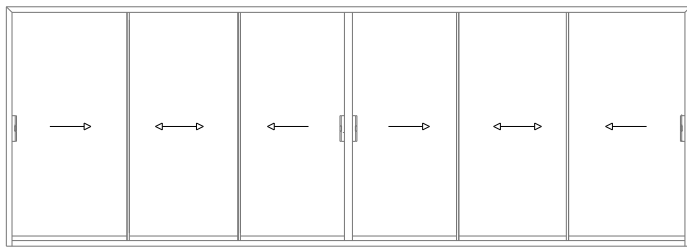

TRI RAIL  
XXXXXX

# Glide 21 - Profiles

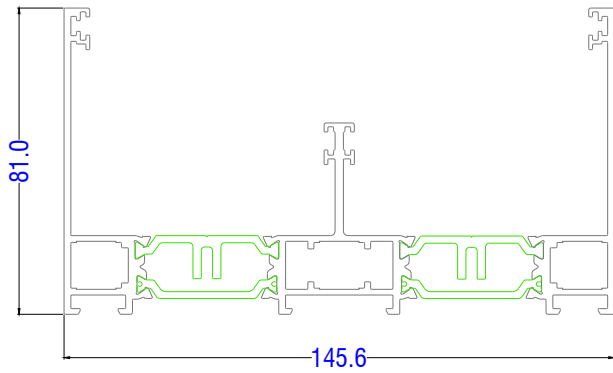

U11025 - Duo Frame

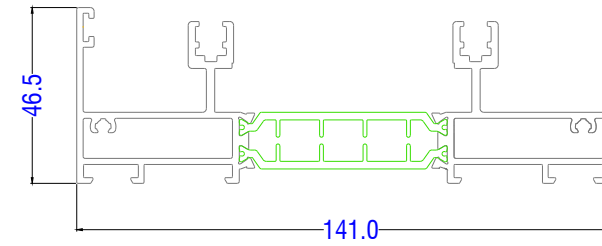

U11028 - Duo Frame Threshold

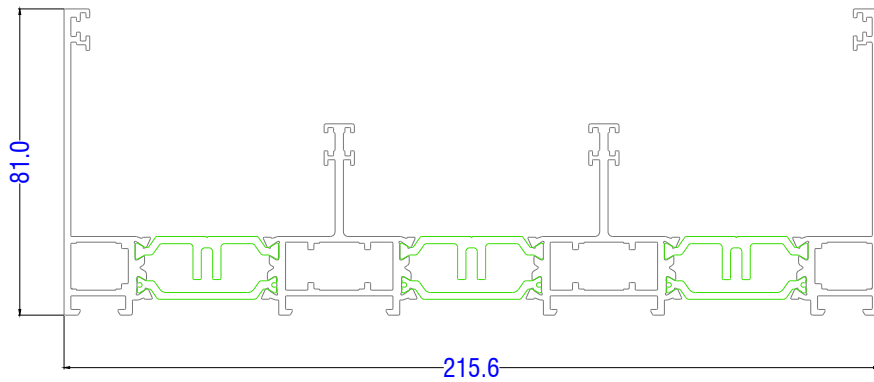

U11064 - Tri Frame

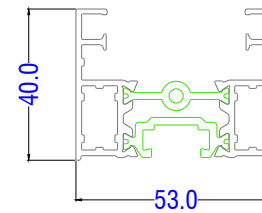

U11121 - Sash Mullion and Upper Rail

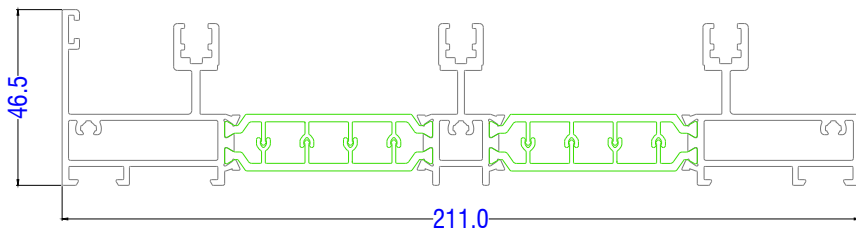

U11065 - Tri Frame Threshold

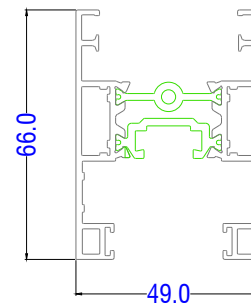

U11122 - Sash Bottom Rail

# Glide 21 - Profiles

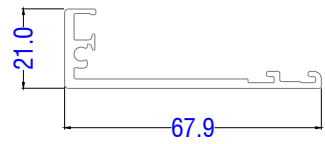

N11123 - Standard interlock

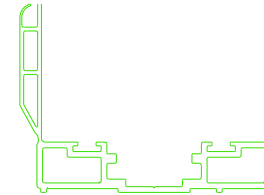

V31214 - Thermal Shield For Frame

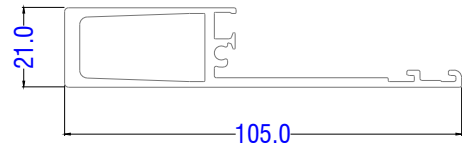

N11120 - Medium interlock



V31213 - Lower Thermal Shield



V31014 - PVC Interlock

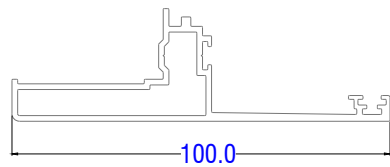

N11901 - Meeting Profile for XXXX Solution



N03650 - Stainless Rail

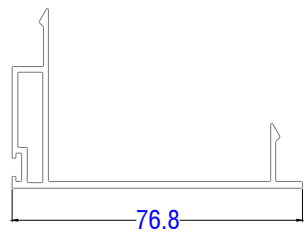

N11900 - Duo Frame Cover

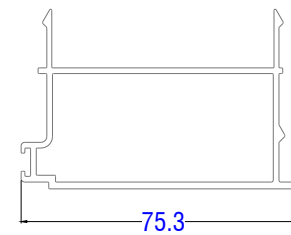

N11909 - Tri Frame Cover

# Glide 21 - Typical Sections

## Duo Frame -Fixed Panel Jamb

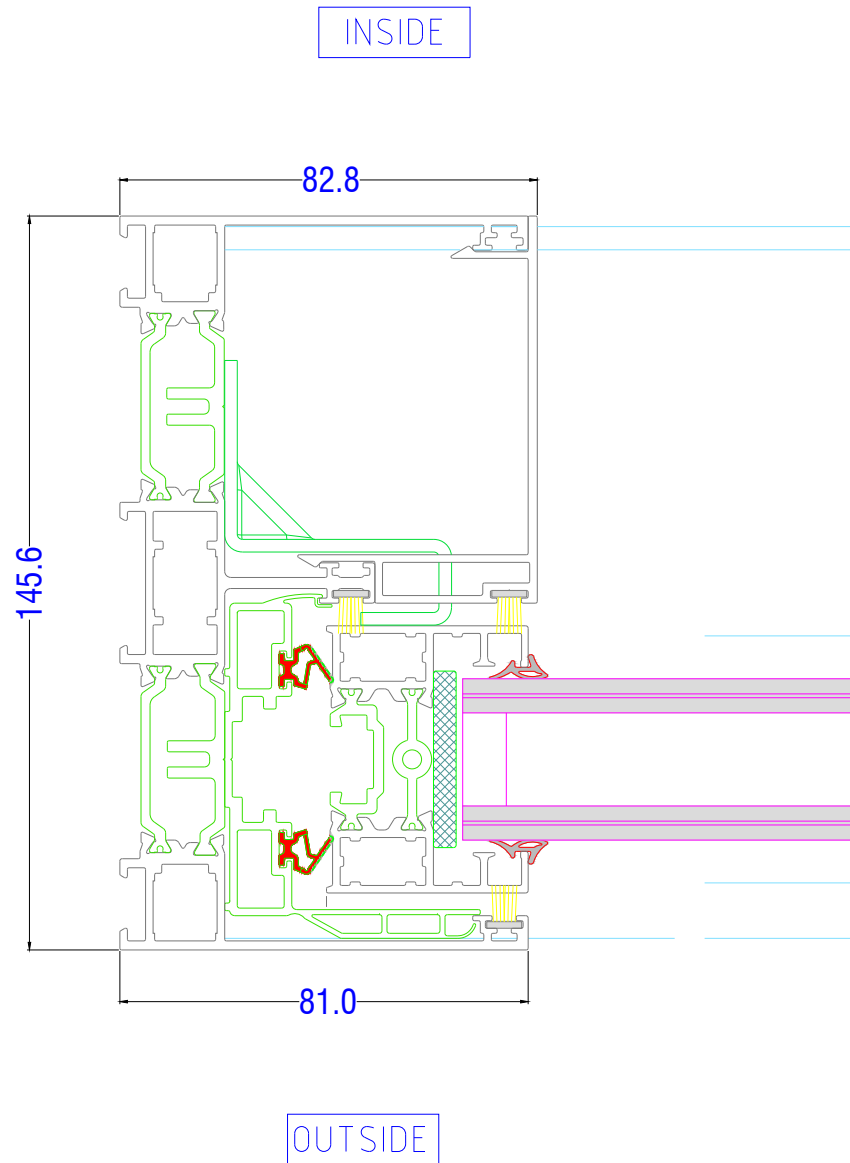
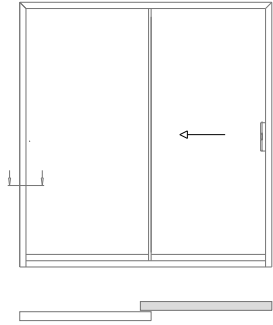

# Glide 21- Typical Sections

## Duo Frame - Sliding Panel Jamb

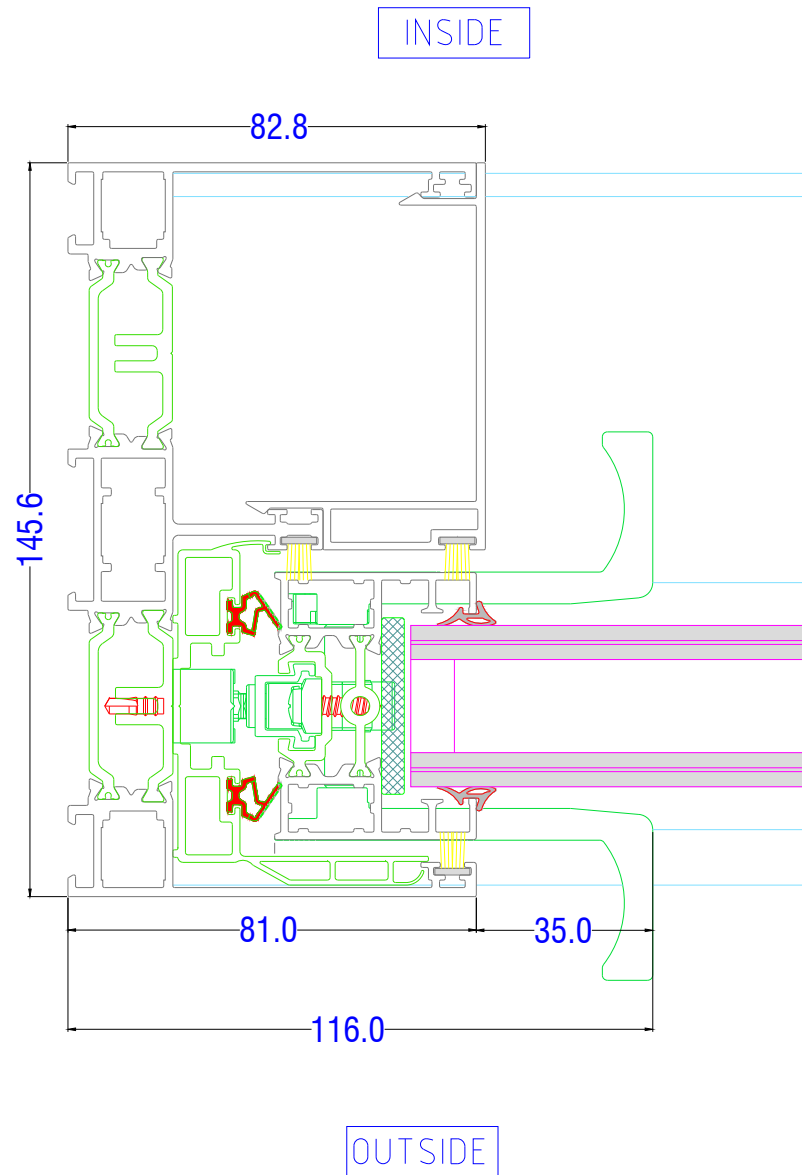
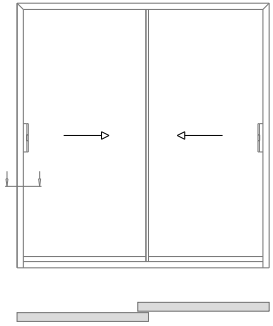

# Glide 21 - Typical Sections

## Tri Frame - Fixed Panel Jamb

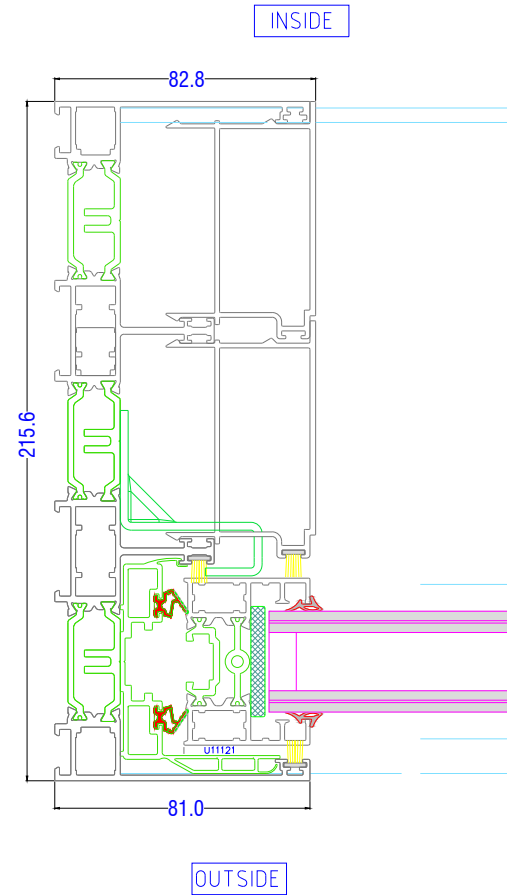
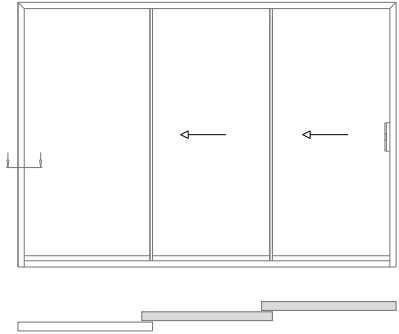

# Glide 21 - Typical Sections

## Tri Frame - Sliding Panel Jamb

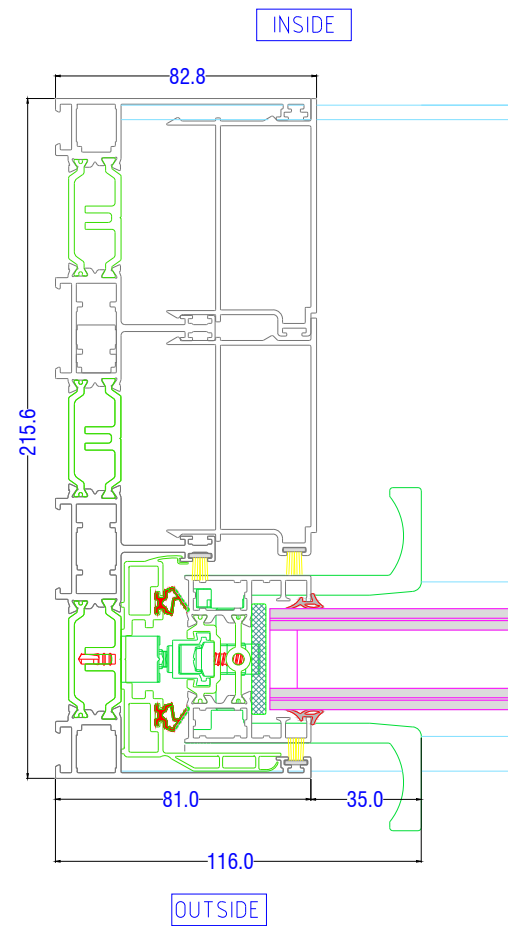
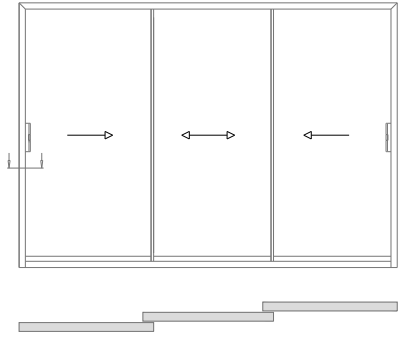

# Glide 21- Typical Sections

Duo Frame - Fixed Panel Threshold

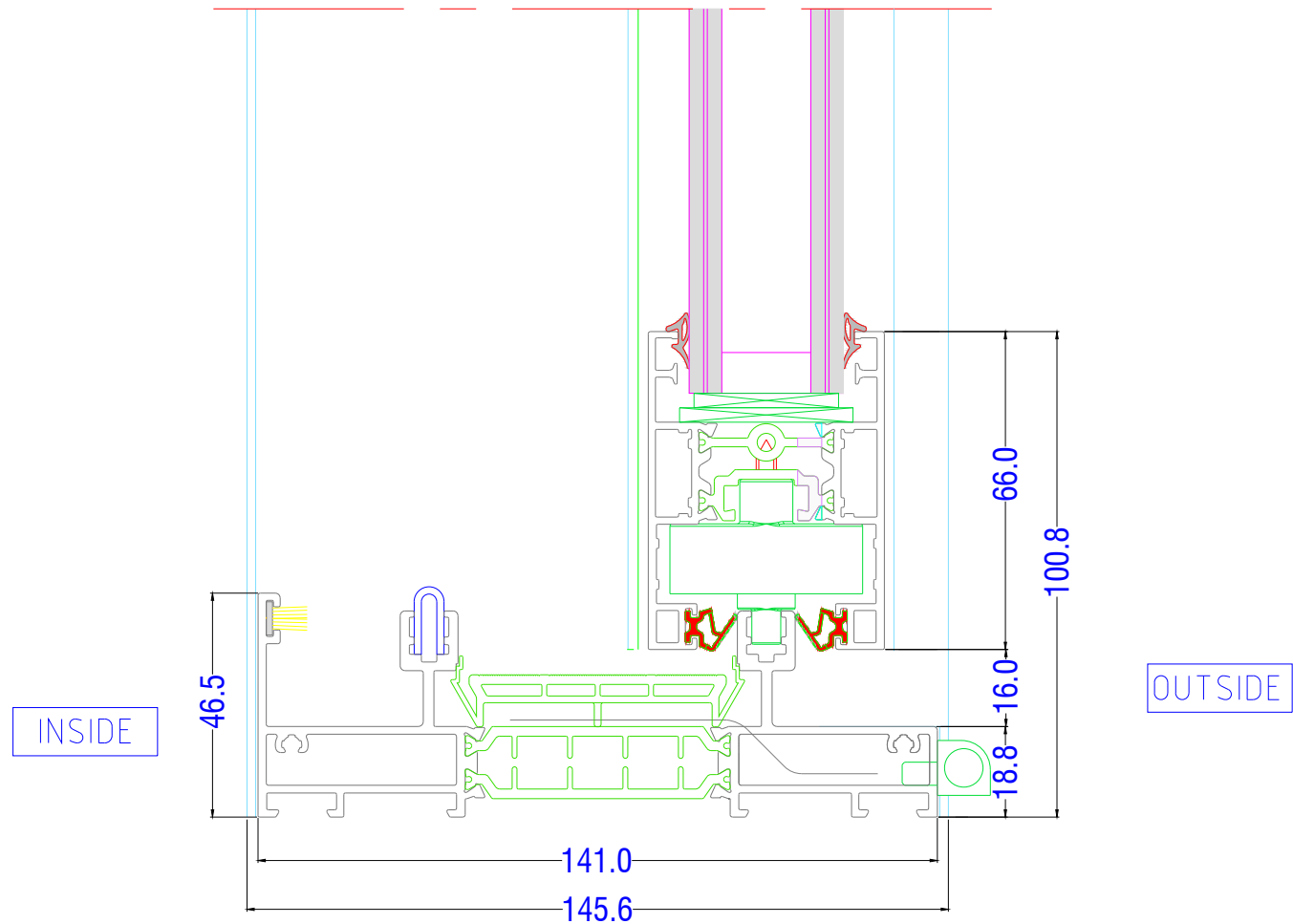
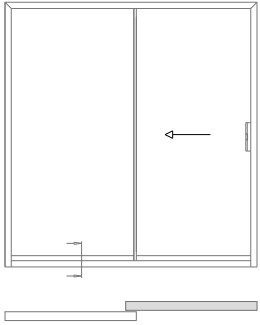

# Glide 21 - Typical Sections

## Duo Frame - Sliding Panel Threshold

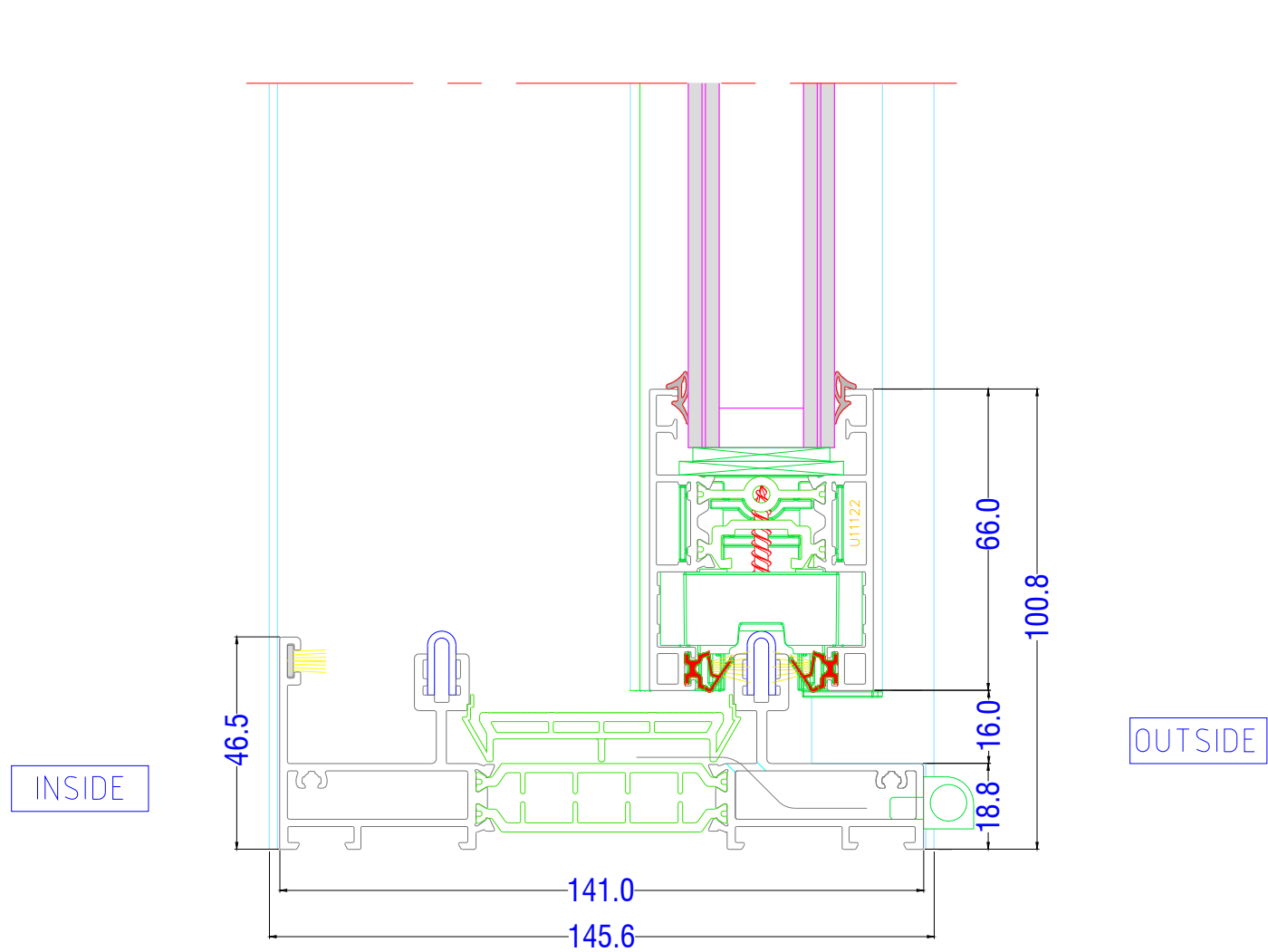
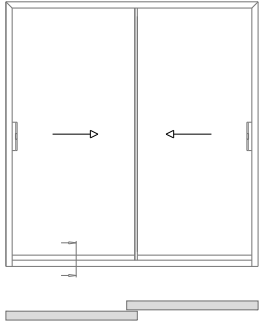

# Glide 21 - Typical Sections

## Tri Frame - Fixed Panel Threshold

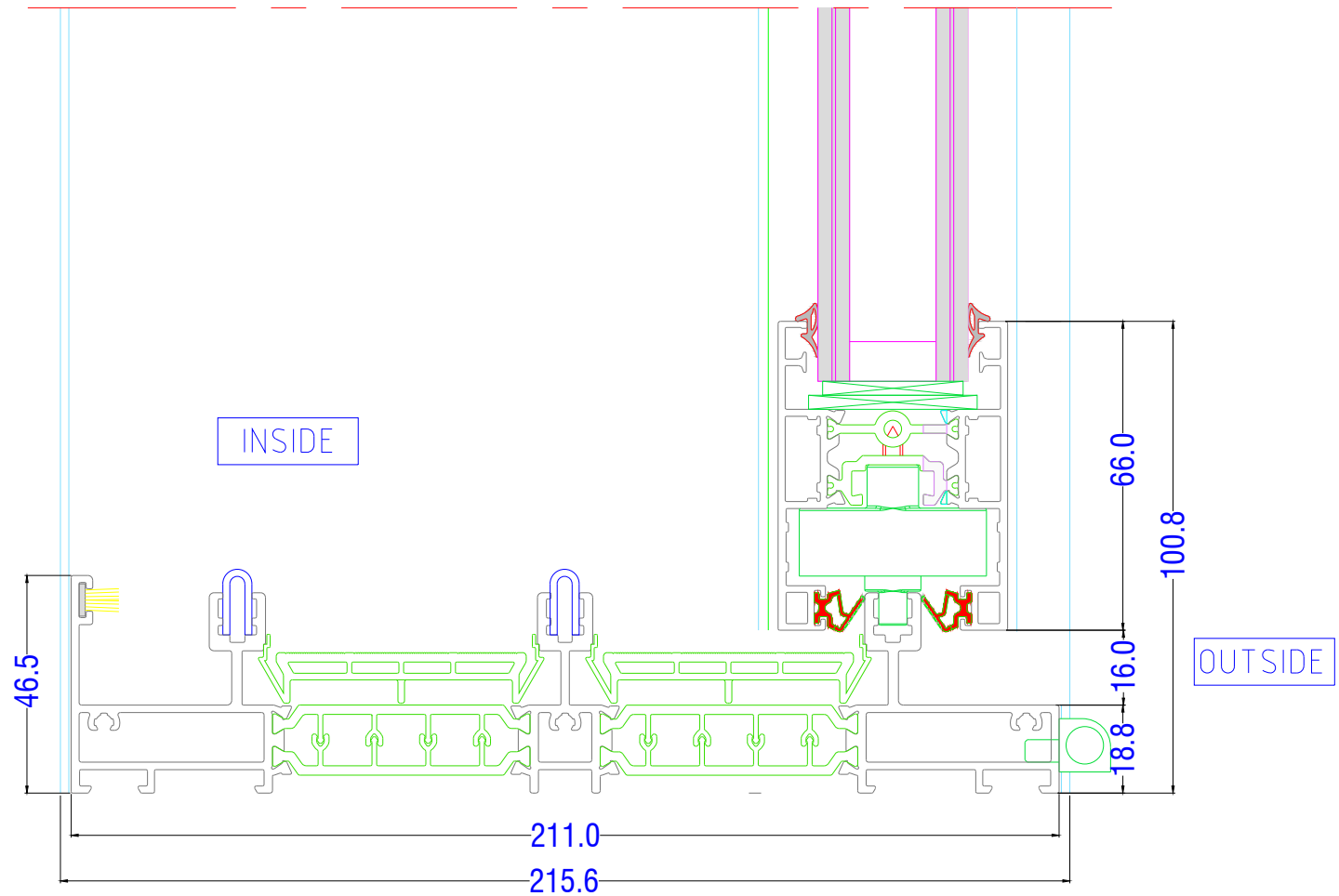
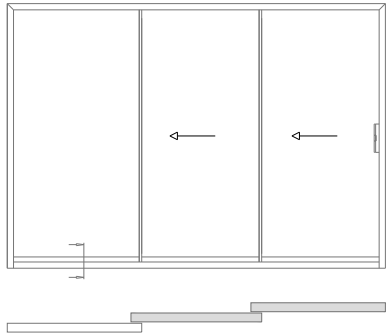

# Glide 21 - Typical Sections

## Tri Frame - Sliding Panel Threshold

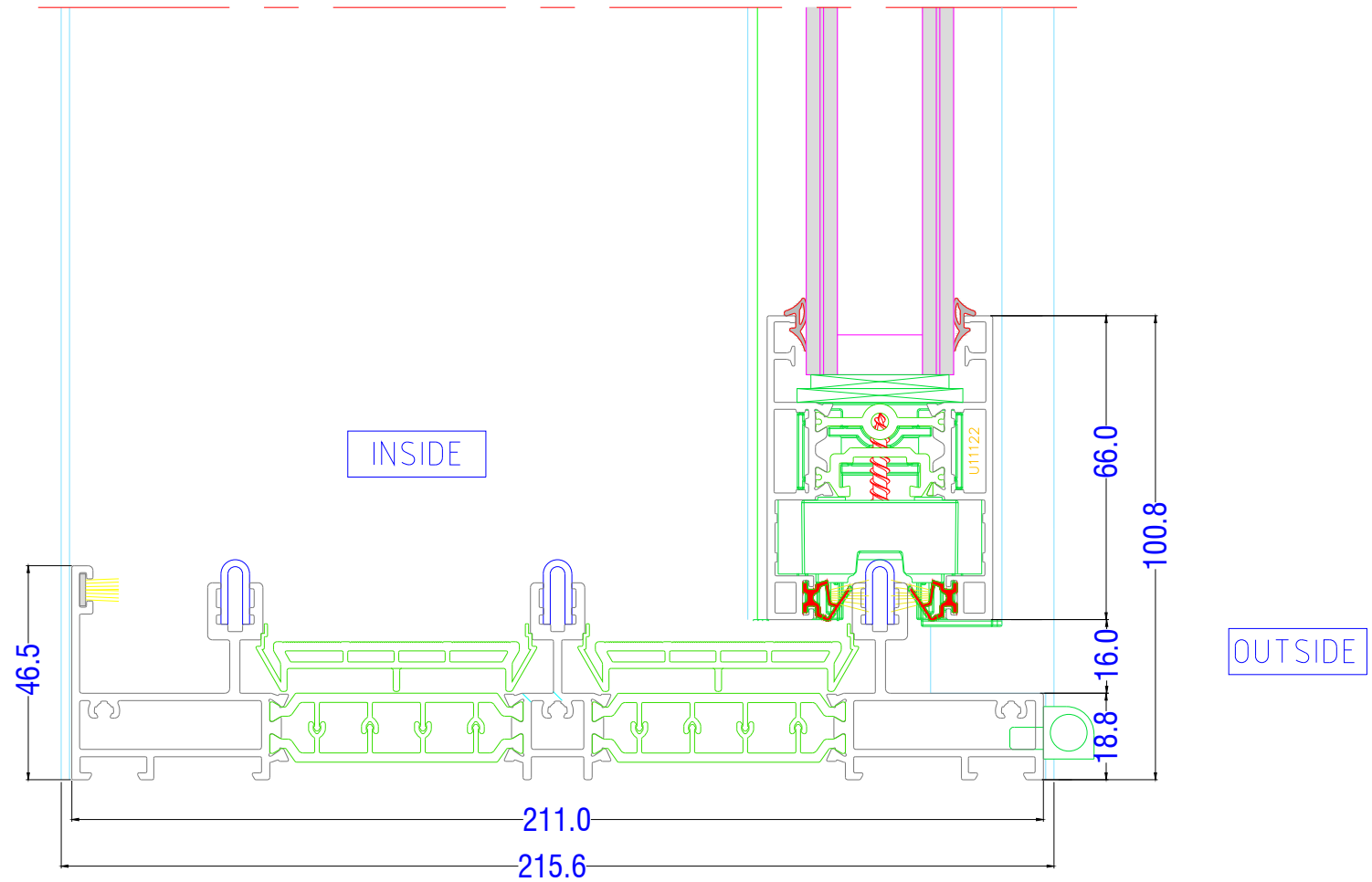
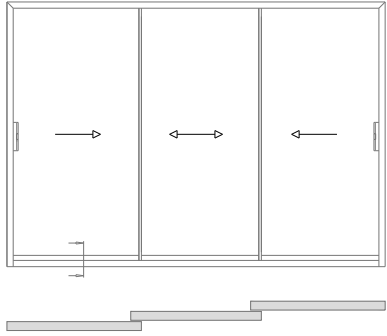

# Glide 21 - Typical Sections

Duo Frame - Fixed Panel Head

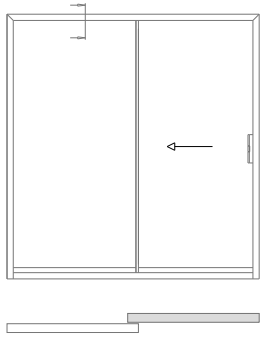

INSIDE

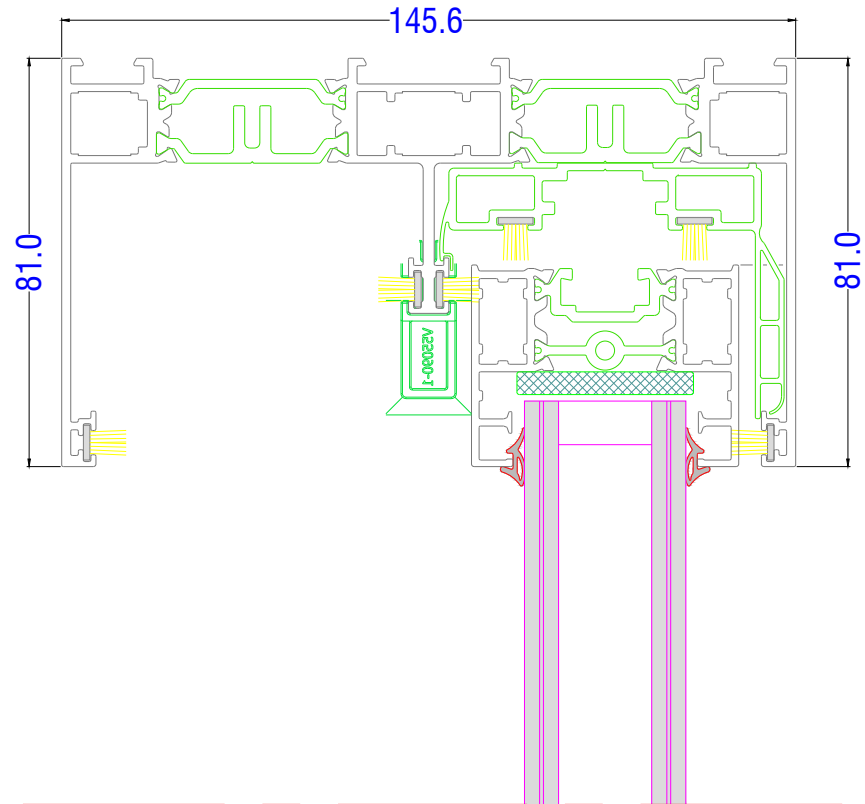

OUTSIDE

# Glide 21 - Typical Sections

## Duo Frame - Sliding Panel Head

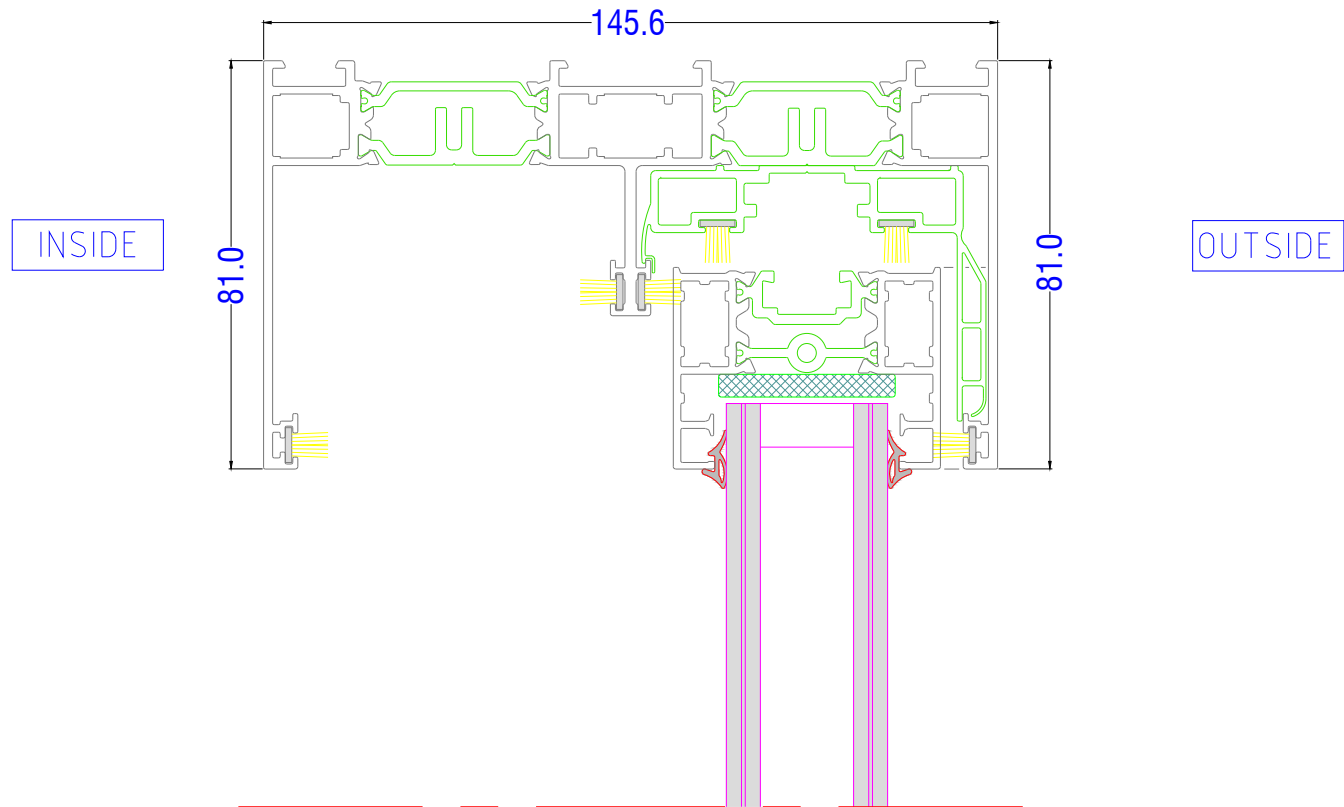
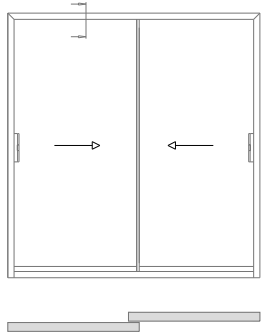

# Glide 21 - Typical Sections

Tri Frame - Fixed Panel Head

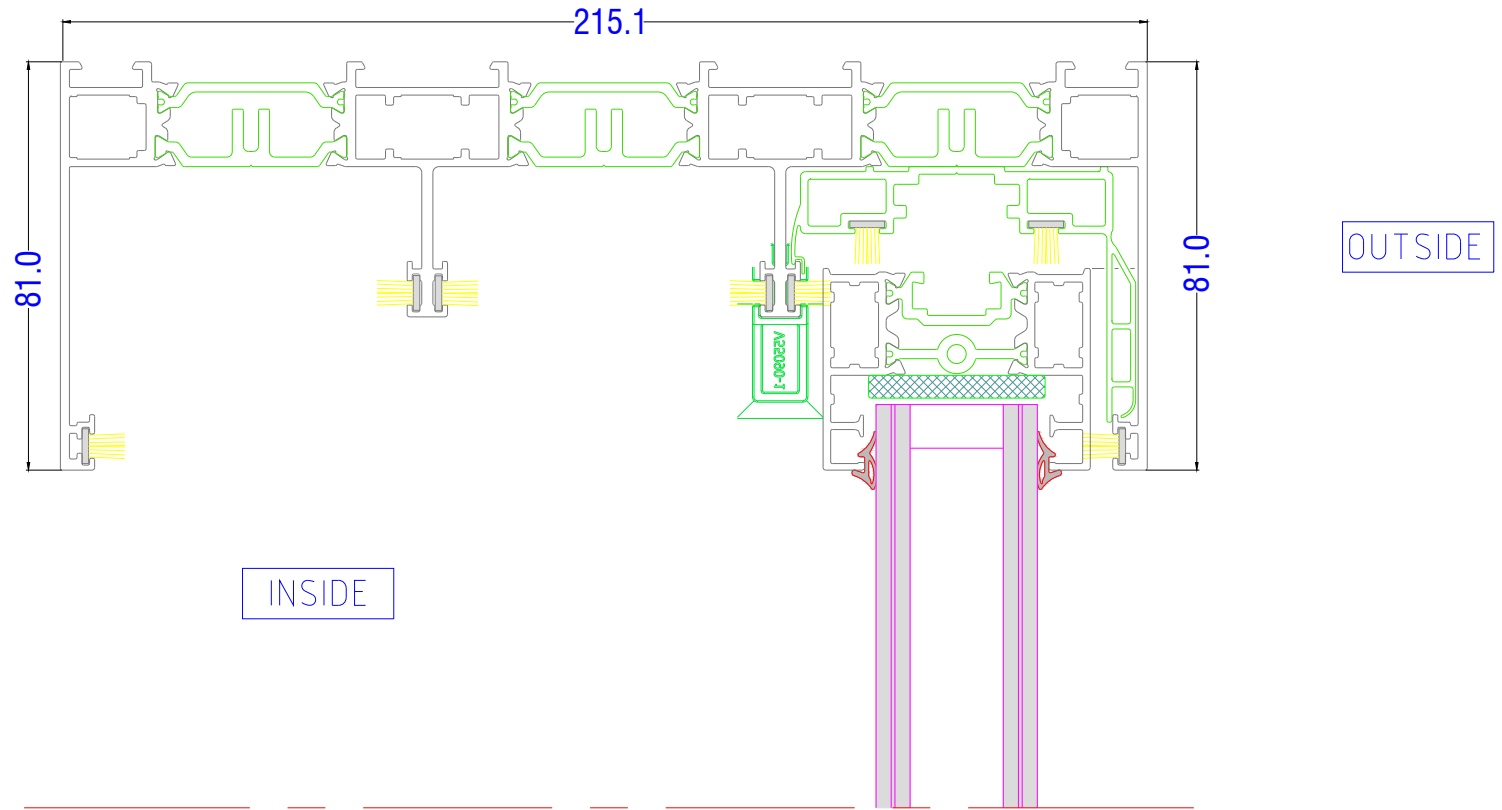
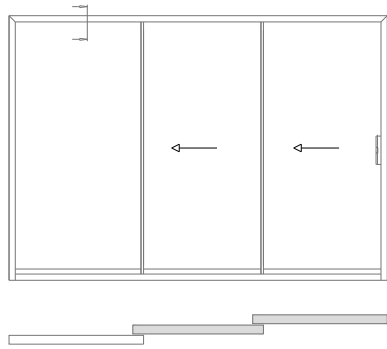

# Glide 21 - Typical Sections

## Tri Frame - Sliding Panel Head

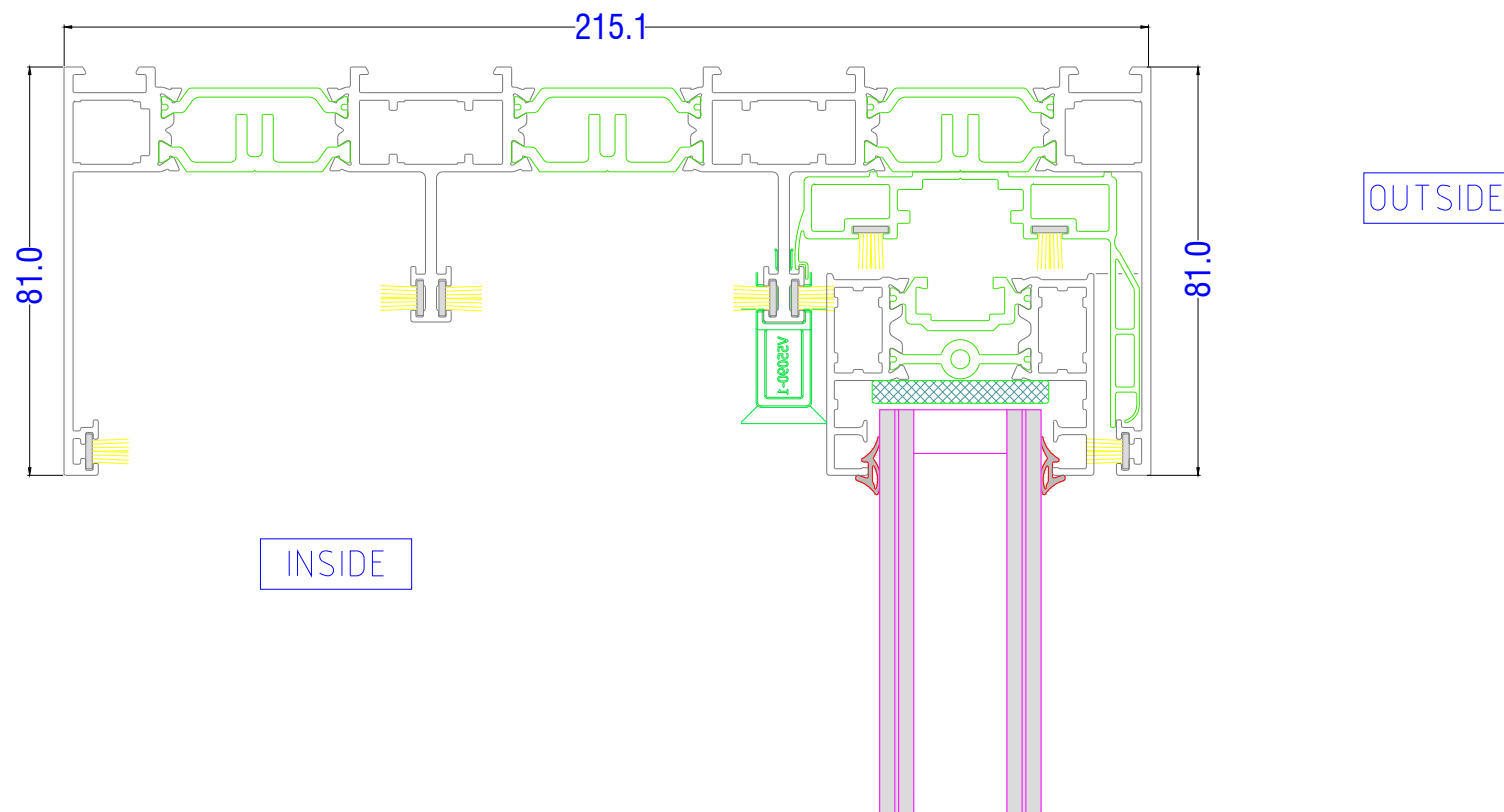
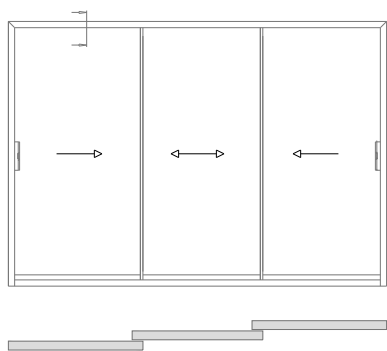

# Glide 21 - Typical Sections

Interlock Slide - Standard Profile

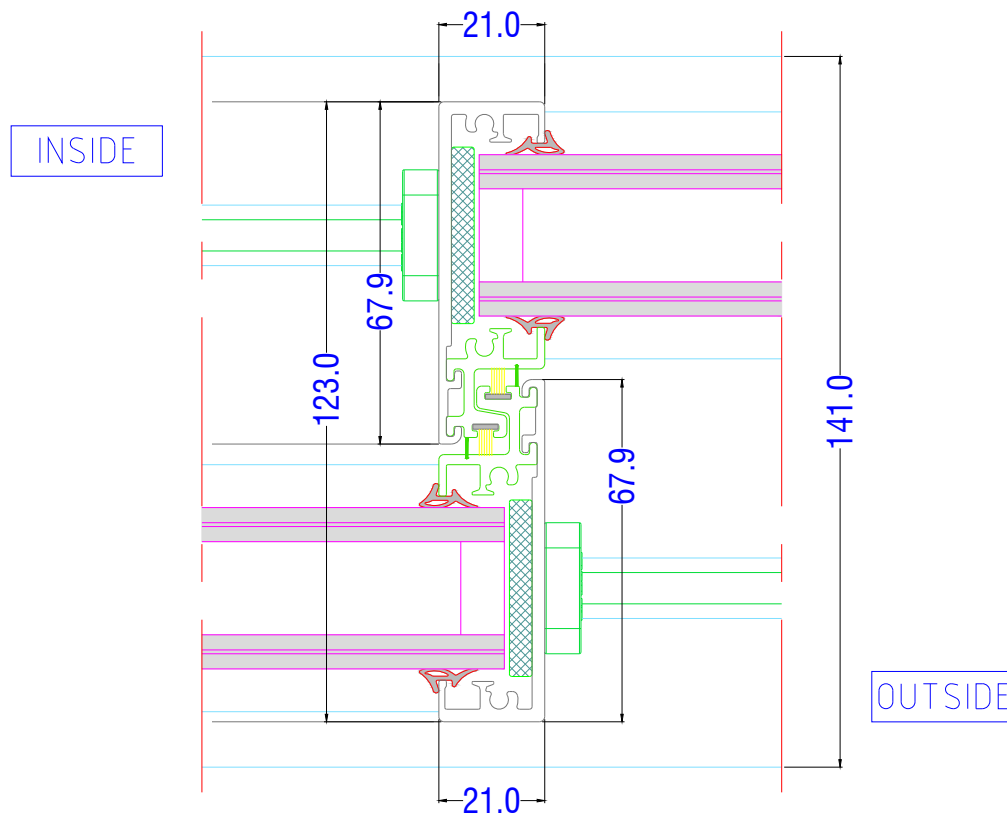
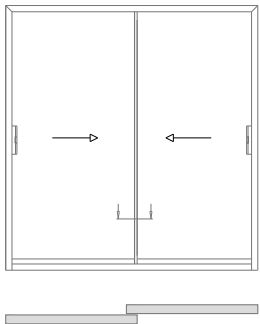

# Glide 21 - Typical Sections

Interlock Slide - Reinforced Profile Outside Only

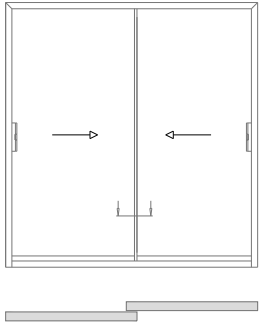

INSIDE

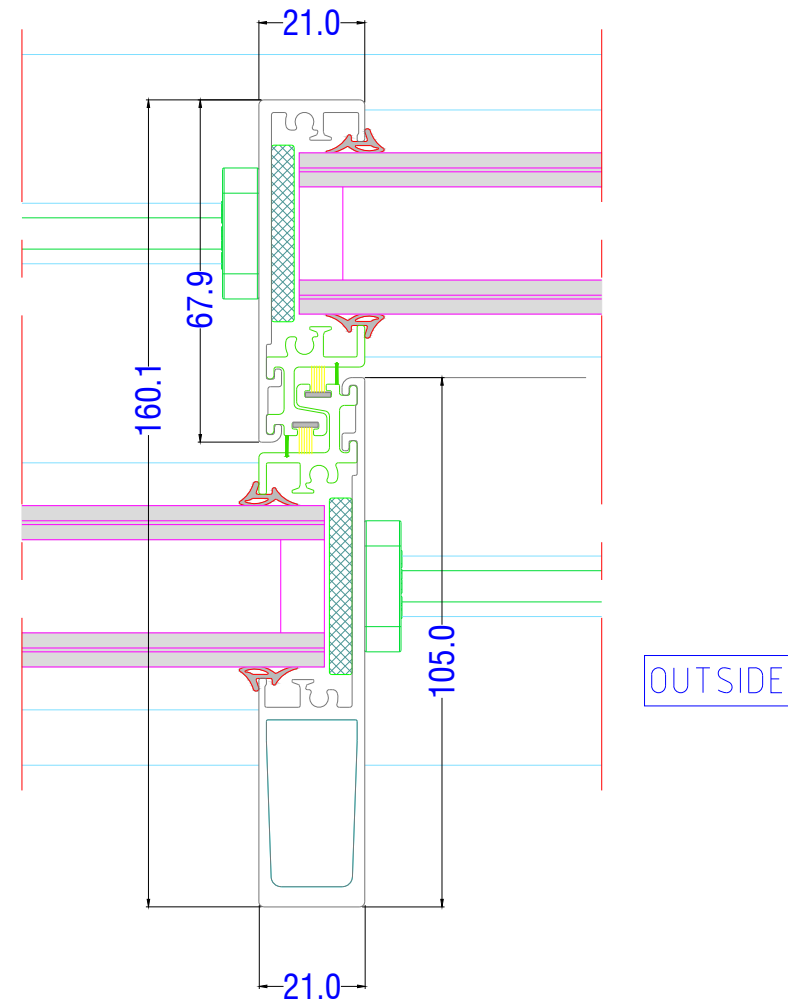

OUTSIDE

# Glide 21 - Typical Sections

Interlock Slide - Reinforced Profile Inside and Outside

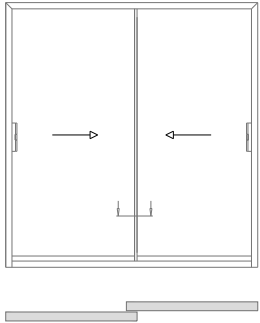

INSIDE

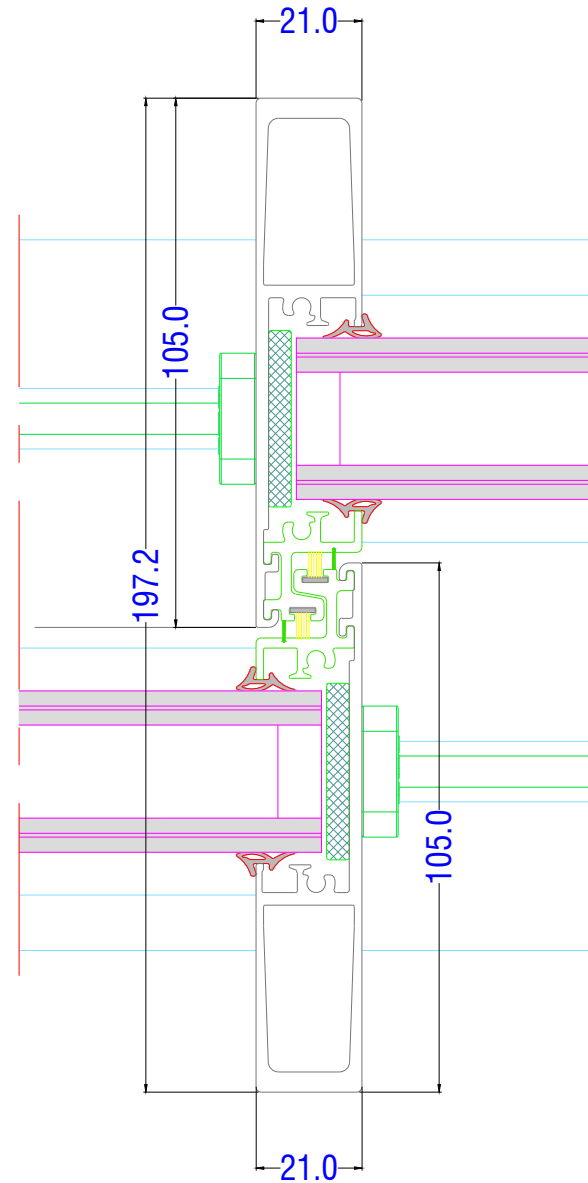

OUTSIDE

# Glide 21 - Typical Sections

## Meeting Stile

